

**Model 7300 and 7305
Spectrophotometer**

JENWAY

Operating Manual

Bibby Scientific

730 005 REV E/12-14

Safety

Please read this information carefully prior to installing or using this equipment.

1. The unit described in this manual is designed to be operated only by trained personnel. Any adjustments, maintenance and repair must be carried out as defined in this manual, by a person qualified to be aware of the hazards involved.
2. It is essential that both operating and service personnel employ a safe system of work, in addition to the detailed instructions specified in this manual.
3. Other than for those items defined in the maintenance procedures herein there are no user serviceable items in this instrument. Removal of covers and attempted adjustment or service by unqualified personnel will invalidate the warranty and may incur additional charges for repair.
4. References should always be made to the Health and Safety data supplied with any chemicals used. Generally accepted laboratory procedures for safe handling of chemicals should be employed.
5. If it is suspected that safety protection has been impaired in any way, the unit must be made inoperative and secured against any intended operation. The fault condition should immediately be reported to the appropriate servicing authority.

Merci de lire attentivement ces informations avant d'installer ou d'utiliser cet appareil.

1. L'appareil décrit dans ce manuel est conçu pour être utilisé uniquement par des personnes formées. Tout réglage, maintenance ou réparation doit être effectué comme décrit dans ce manuel, par une personne qualifiée consciente des risques encourus.
2. Il est essentiel que les personnes utilisant et intervenant sur cet appareil respectent les règles de sécurité de travail, en plus des instructions détaillées précisées dans ce manuel.
3. En-dehors des éléments décrits dans les procédures de maintenance ci-incluses, cet appareil ne contient aucun élément réparable par l'utilisateur. L'enlèvement des capots et les tentatives de réglage ou de réparation par des personnes non qualifiées invalide toute garantie et entraîne un risque de frais de réparation supplémentaires.
4. Toujours se référer aux fiches techniques de santé et de sécurité accompagnant tout produit chimique utilisé. Respecter les procédures de laboratoire généralement acceptées pour la manipulation en toute sécurité des produits chimiques.
5. Si l'utilisateur suspecte qu'un problème quelconque puisse mettre en cause la sécurité, l'appareil doit être rendu inopérant en empêchant son utilisation. Communiquer la défaillance constatée au service de maintenance compétent.

Bitte lesen Sie diese Hinweise vor Installation oder Gebrauch dieser Ausrüstung sorgfältig durch.

1. Das in diesem Handbuch beschriebene Gerät darf nur von geschultem Personal bedient werden. Alle Anpassungen, Wartungsarbeiten und Reparaturen müssen entsprechend der Vorgaben in diesem Handbuch und von einer kompetenten Person, die mit den damit verbundenen Gefahren vertraut ist, durchgeführt werden.
2. Es ist wichtig, dass sowohl das Bedienungs- als auch das Service-Personal zusätzlich zu den detaillierten Anweisungen in diesem Handbuch ein sicheres Arbeitssystem einsetzen.
3. Mit Ausnahme der Teile, deren Wartungsverfahren in diesem Handbuch beschrieben sind, enthält dieses Gerät keine weiteren Teile, die vom Benutzer gewartet werden können. Das Entfernen von Abdeckungen und Versuche von hierfür unqualifiziertem Personal, Anpassungen oder Wartungsarbeiten durchzuführen, haben zur Folge, dass die Garantie verfällt und können zusätzliche Reparaturkosten auslösen.
4. Es ist jederzeit auf die sicherheitsrelevanten Daten sämtlicher verwendeter Chemikalien Bezug zu nehmen. Allgemein anerkannte Labormethoden zum sicheren Umgang mit Chemikalien sollten eingesetzt werden.
5. Besteht der Verdacht, dass die Sicherheitsvorrichtungen in irgendeiner Weise beschädigt wurden, muss das Gerät außer Betrieb genommen und gegen weiteren Gebrauch gesichert werden. Die Störung sollte der zuständigen Serviceeinrichtung unverzüglich gemeldet werden.

Leggere attentamente queste istruzioni prima di installare o utilizzare il dispositivo.

1. L'unità descritta nel presente manuale è stata realizzata per essere utilizzata solo da personale che ha ricevuto l'apposita formazione. Qualsiasi operazione di regolazione, manutenzione e riparazione deve essere effettuata sulla base di quanto indicato nel presente manuale da personale qualificato consapevole dei rischi connessi.
2. È fondamentale che il personale operativo e il personale addetto alla manutenzione utilizzino un sistema di lavoro sicuro, oltre a seguire le istruzioni specificate nel presente manuale.
3. Oltre a quelli indicati nelle procedure di manutenzione, all'interno di questo dispositivo non sono presenti altri elementi sui quali è possibile effettuare interventi. La rimozione delle protezioni e qualsiasi tentativo di regolazione o di manutenzione posto in essere da personale non qualificato invaliderà la garanzia. In questi casi, sarà necessario pagare un importo per le riparazioni effettuate.
4. È sempre necessario fare riferimento ai dati sulla salute e sulla sicurezza forniti con le sostanze chimiche utilizzate. Adottare le procedure di laboratorio generalmente accettate per la gestione delle sostanze chimiche.

5. Nel caso in cui si sospetti che la salute possa essere pregiudicata in qualsiasi modo, disattivare l'unità per renderla inutilizzabile. Qualsiasi condizione di errore deve essere immediatamente segnalata al responsabile per la manutenzione.

Lea esta información atentamente antes de instalar o utilizar este equipo.

1. La unidad descrita en este manual está diseñada para que solamente la utilice personal con formación. Cualquier operación de ajuste, mantenimiento y reparación debe llevarse a cabo del modo indicado en este manual y debe realizarla una persona cualificada que sea consciente de los peligros que implica.
2. Es fundamental que tanto los operarios como el personal de servicio utilicen un sistema de trabajo seguro, así como las instrucciones detalladas que se especifican en este manual.
3. Cualquier elemento que no se encuentre entre los definidos en los procedimientos de mantenimiento aquí descritos no podrá utilizarse en este instrumento. La extracción de las tapas y los intentos de ajuste o reparación por parte de personal no cualificado invalidarán la garantía y pueden incurrir en cargos adicionales por reparación.
4. Siempre deberían consultarse los datos sobre Salud y Seguridad que se suministran con cualquier producto químico que se utilice. Es necesario llevar a cabo los procedimientos de laboratorio de aceptación generalizada para la manipulación segura de productos químicos.
5. Si existe la sospecha de que las medidas protectoras de seguridad han quedado dañadas en cualquier modo, la unidad debe inutilizarse y protegerse contra toda operación que se intente llevar a cabo. El estado de fallo debe comunicarse inmediatamente a la autoridad de servicio de mantenimiento y reparación pertinente.

Contents

Safety	3
Contents	6
SECTION 1 - Introduction	8
1.1 INSTRUMENT DESCRIPTION.....	8
1.2 INSTRUMENT SPECIFICATION.....	8
SECTION 2 – Installation	9
2.1 UNPACKING.....	9
2.2 INSTALLATION	9
2.3 DISPLAY	10
2.4 CONTROLS.....	11
2.5 REAR PANEL.....	12
2.6 FRONT PANEL.....	12
SECTION 3 – Theory and Practice of Spectroscopy Measurements	13
3.1 THEORY OF SPECTROSCOPY MEASUREMENT	13
3.2 SPECTROSCOPY MEASUREMENT	14
3.3 GOOD PRACTICE GUIDELINES.....	15
SECTION 4 – Instrument Setup	17
4.1 NAVIGATING AND SCREEN SETUP	17
4.2 TIME AND DATE	18
4.3 INSTRUMENT SETTINGS MENU.....	18
4.4 SCREEN CONTRAST	19
4.5 LAMP SAVE.....	19
SECTION 5 – PHOTOMETRICS	21
5.1 MODE SPECIFIC PARAMETERS	21
5.2 METHOD SET UP	21
5.2.1 Selecting a Wavelength	21
5.3 CALIBRATION.....	22
5.4 SAMPLE MEASUREMENT.....	22
SECTION 6 – CONCENTRATION	23
6.1 MODE SPECIFIC PARAMETERS	23
6.2 METHOD SETUP	23
6.2.1 Selecting a Wavelength	23
6.2.2 Settings	24
6.2.2.1 Selecting Concentration Units	24
6.2.2.2 Changing the Resolution	25
6.2.2.3 Using a Standard	25
6.2.2.4 Using a Factor	25
6.3 CALIBRATION.....	26
6.3.1 Calibrating to a Standard	26
6.3.2 Calibrating to a Factor	27
6.4 SAMPLE MEASUREMENT	27
6.4.1 Measuring a Sample After Calibrating to a Standard	27
6.4.2 Measuring a Sample After Calibrating to a Factor	27
6.5 POST MEASUREMENT OPTIONS.....	27
6.5.1 Changing Concentration Units.....	28
6.5.2 Changing the Concentration Factor.....	29

6.5.3	Changing the Calibration Standard Value	29
SECTION 7 – PRINTING AND AUTOLOGGING		30
7.1	PRINTING.....	30
7.1.1	Print Setup	30
7.1.2	Printing Results.....	31
7.2	AUTOLOGGING	31
7.2.1	Setting the Number of Sample Repetitions	31
7.2.2	Selecting Result's Destination	32
7.3	CONNECTING TO A PC	33
SECTION 8 – Accessories and Spare Parts		34
8.1	OPTIONAL ACCESSORIES.....	34
8.2	CONNECTING THE ACCESSORIES	34
8.2.1	Internal Printer	34
8.2.2	Passive Accessories.....	35
8.2.2.1	Water-heated cuvette holder	35
8.2.3	Active Accessories.....	38
8.2.3.1	Automatic 8 cell turret	38
8.2.3.2	Peltier.....	39
8.2.3.3	Sipper pump	40
8.2.3.4	Combined sipper Peltier pump	42
8.3	USING THE ACCESSORIES	43
8.3.1	Automatic 8 cell turret.....	43
8.3.2	Peltier.....	43
8.3.3	Sipper pump	44
8.3.3.1	Manual Sipper Pump Settings	45
8.3.3.2	Timed Sipper Pump Settings	46
8.3.4	Combined sipper Peltier pump	49
8.4	SPARES	49
SECTION 9 – Maintenance and Service		50
9.1	ROUTINE MAINTENANCE	50
9.2	LAMP REPLACEMENT	50
9.2.1	Tungsten Halogen Lamp Replacement.....	50
9.2.2	Xenon Lamp Module Replacement	51
9.3	SERVICE	51
SECTION 10 – Troubleshooting.....		52
10.1	ERROR CODES	52
10.2	TROUBLESHOOTING GUIDE	54
10.3	TECHNICAL SUPPORT	54
SECTION 11 – Declaration of Conformity.....		55

SECTION 1 - Introduction

1.1 INSTRUMENT DESCRIPTION

The 7300 and 7305 spectrophotometers are suited to a wide range of applications in education, quality control, environmental and clinical analysis. The 7300 is a visible spectrophotometer covering a wavelength range from 320nm to 1000nm. The 7305 is a UV/Visible spectrophotometer with a wavelength range from 198nm to 1000nm. Both models feature measurement modes for absorbance, % transmittance and concentration. These instruments use icon driven software and have an improved navigation system for easy and intuitive usability.

1.2 INSTRUMENT SPECIFICATION

	7300	7305
Wavelength		
Range	320 to 1000nm	198 to 1000nm
Resolution	1nm	
Accuracy	± 2nm	
Repeatability	± 0.5nm	
Spectral bandwidth	5nm	
Photometrics		
Transmittance	0 to 199.9%	
Absorbance	-0.300 to 2.500A	
Accuracy	±1%T, ±0.01Abs at 1.000 Absorbance	
Resolution	0.1%T, 0.001A	
Stray light	<0.5% at 340nm	<0.5% at 340nm and 220nm
Stability	<0.002Abs/hr after 30 minute warm up	<0.001Abs/hr without warm up
Concentration		
Range	-300 to 9999	
Resolution	Selectable 1/0.1/0.01/0.001	
Calibration	Blank with a single standard or factor	
Units	no units, %, ppm, EBC, SRM, mEq/l, mEq, M, mM, µM, nM, U, U/l, U/ml, g/l, mg/l, µg/l, ng/l, g/dl, mg/dl, µg/dl, mg/ml, µg/ml, ng/ml, µg/µl, ng/µl, mol/l, mmol/l	
Factor	0.001 to 10000	
Standard	0.001 to 1000	
Other		
Beam height	15mm	
Light source	Tungsten halogen lamp	Xenon lamp
Lamp save	Yes	Not applicable
GLP	Current time and date	
Outputs	Analogue, RS232, Internal printer	
Power	24V	
Size (w x d x h)	275 x 400 x 220mm	
Weight	6kg	

SECTION 2 – Installation

2.1 UNPACKING

Remove the 7300 or 7305 from the packaging and ensure the following items are included:

1. Model 7300 spectrophotometer (730 001), or Model 7305 spectrophotometer (730 501)
2. 24V 65W power supply unit (021 060)
3. 7300 - Pack of 100 disposable plastic visible wavelength cuvettes (060 084),
7305 - Pack of 100 disposable UV plastic cuvettes (060 230)
4. Jenway 73 series PC software (735 100) and interface cable (013 203)
5. Instruction manual (730 005)
6. Jenway Foreign Manual CD (JENMANCD)
7. Optional accessories (as ordered)

2.2 INSTALLATION

Models 7300 and 7305 are supplied ready to use.

The unit should be placed on a clean flat surface which is free from drafts and vibrations. The units are designed for operation on 90V to 264V AC input at 47 to 63Hz. Select the correct plug attachment and attach to the power supply unit as shown below:

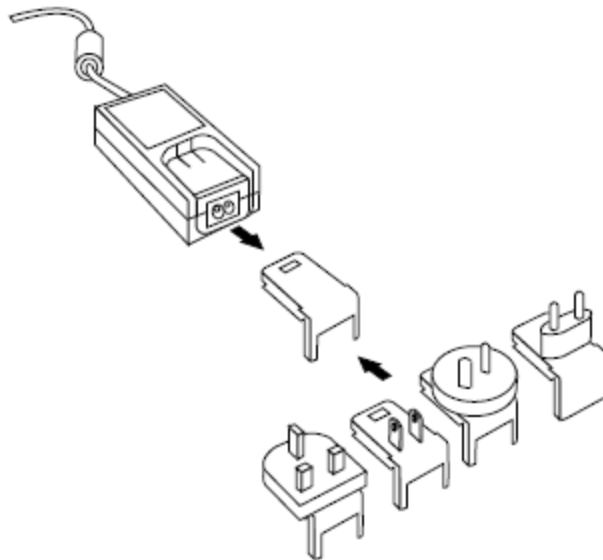

Fig 2.2.1 – Power supply unit with various plugs

Connect the power supply unit to the power inlet socket on the rear panel of the instrument and connect to the mains socket. Turn the power on at the mains and switch the instrument on using the power switch on the rear of the instrument.

The instrument will perform several power on tests before displaying the main menu:



Fig 2.2.2 – All Power On Tests Complete

1. Instrument check – ensures the validity of the saved parameters
2. Dark test
3. Checks for the accessory fitted. If an active accessory is found the instrument verifies communication and response
4. Self-calibration of wavelengths

2.3 DISPLAY

These spectrophotometers have a dot matrix display which enables icons to be displayed clearly. Following successful completion of the power on tests the main menu screen will be displayed:

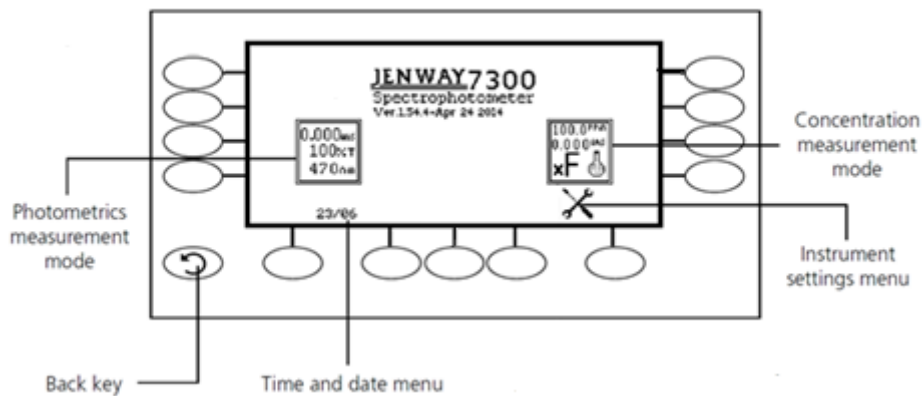

Fig. 2.3 – Display

2.4 CONTROLS

The keypad used for these models enables an easy and effective way of navigating the different measurement modes, entering numbers, saving and analysing results. The soft keys are active when an icon is displayed above or adjacent to the key. The only exception to this is the back key which is always active.

The main menu screen and surrounding keypad is displayed below.

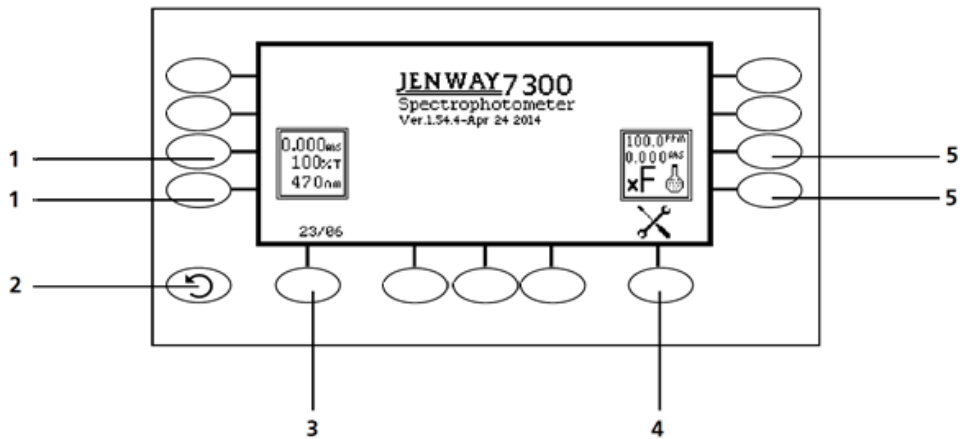

Fig. 2.4 – Display

1. Photometrics measurement mode
2. Back key
3. Time and date menu
4. Instrument settings menu
5. Concentration measurement mode

2.5 REAR PANEL

The image below shows the rear panel on the instrument:

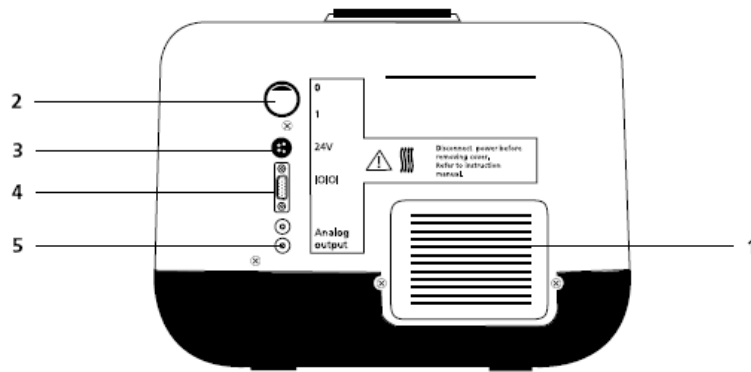

Fig. 2.5.1 – Rear Panel

- | | |
|----------------------|---|
| 1. Lamp access panel | Allows access to lamp when replacement is necessary |
| 2. Power switch | On/off switch for the unit |
| 3. Power in socket | Connection socket for power supply unit |
| 4. RS232 serial port | Connection to a PC or external serial printer |
| 5. Output sockets | Analogue output |

2.6 FRONT PANEL

The image below shows the front panel of the instrument:

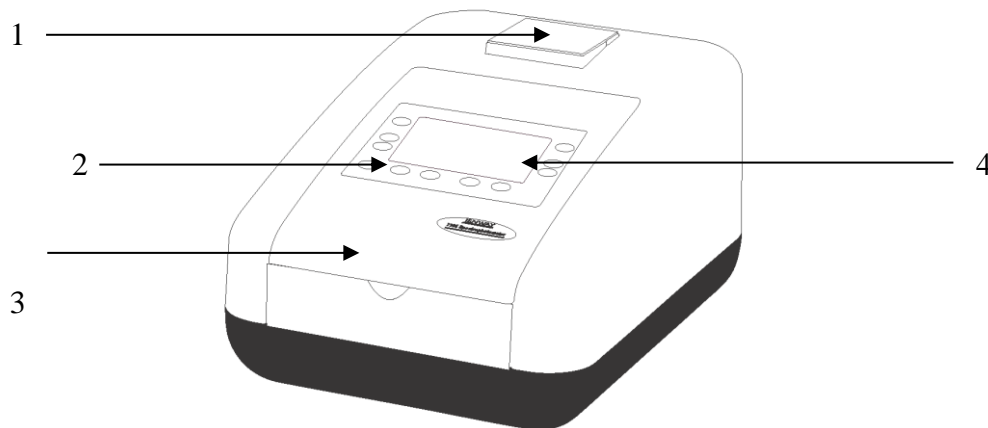

Fig. 2.6.1 – Front Panel

1. Integral printer (optional accessory)
2. Keypad
3. Instrument lid
4. Display

SECTION 3 – Theory and Practice of Spectroscopy Measurements

3.1 THEORY OF SPECTROSCOPY MEASUREMENT

UV-visible spectroscopy is the measurement of the absorbance of light at a specific wavelength in a sample. This is used to identify the presence and concentration of molecular entities within the sample. The Beer-Lambert law is used to relate the absorption of light to the properties of the sample through which the light is travelling through. The Beer-Lambert law states that:

$$A = \epsilon l c$$

- A** is the absorbance
- ϵ** is the molar absorption coefficient ($\text{l mol}^{-1}\text{cm}^{-1}$)
- c** is the concentration (mol l^{-1})
- l** is the path length (cm)

This law shows that absorbance is linear to concentration but this is only true for low concentrations. For absorbance levels above 3 the concentration starts to move away from the linear relationship.

Transmittance is the proportion of the light which passes through the sample:

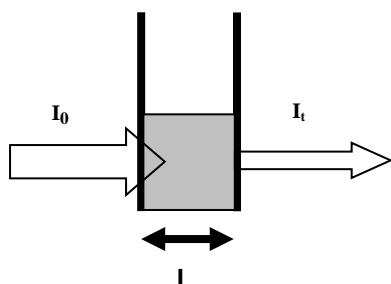

Where:

- I_0 is the incident light
- I_t is the transmitted light
- l is the path length

Therefore:

$$T = \frac{I_t}{I_0}$$

Absorbance is inversely related to transmittance:

$$A = \text{Log} \frac{1}{T}$$

3.2 SPECTROSCOPY MEASUREMENT

There are four main components of a spectrophotometer. These are a light source to emit a high and constant amount of energy over the full wavelength range; a method for separating the light into discrete wavelengths; a sample holder and a light detector.

The optical layout of the 7300 and 7305 spectrophotometers is shown below:

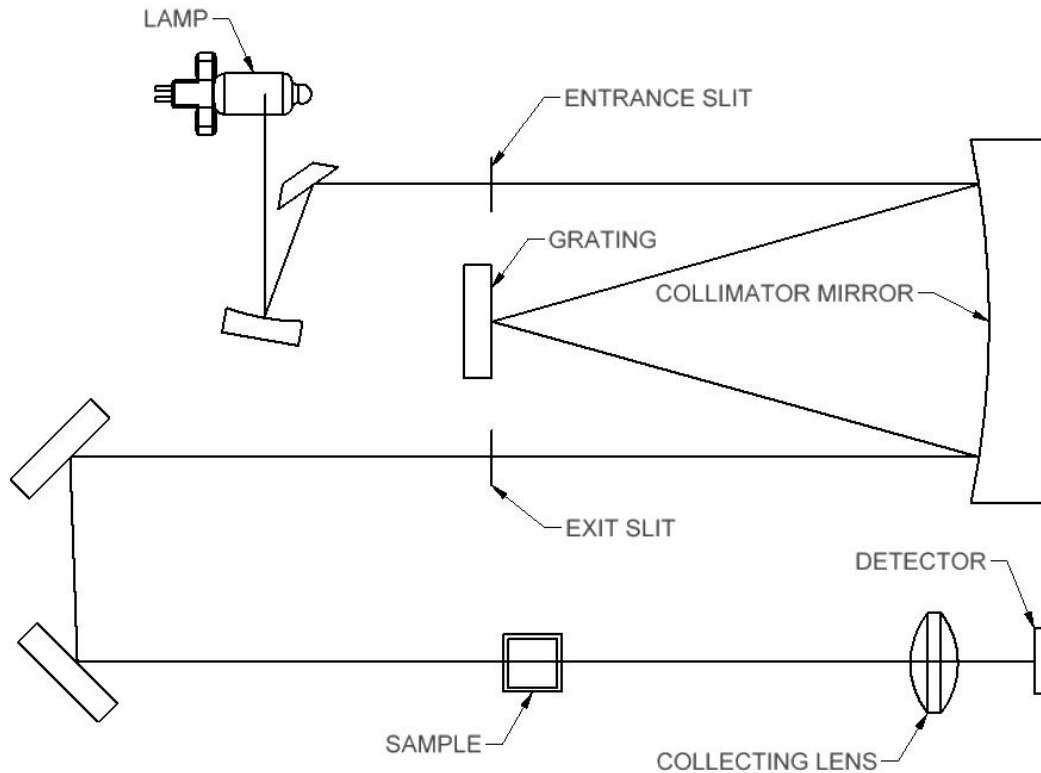

Figure 3.2.1 – Diagram of light path

The light from the pre-focused tungsten halogen (7300) or pre-aligned xenon (7305) lamp is focused onto the grating, with 1200 lines per millimeter, which separates the light into discrete wavelengths. The diffracted spectrum of light then passes through a further slit and lens arrangement before passing through the sample in the sample chamber from left to right. The light which is not absorbed by the sample is transmitted through a collecting lens and onto the signal detector. The photo-diode detector used is mounted directly onto the detector PCB and is used to calculate the % transmittance. The result is displayed either as % transmittance or absorbance on the instrument display.

3.3 GOOD PRACTICE GUIDELINES

1. For optimum performance all spectrophotometers should be sited in a clean, dry, dust free atmosphere. When in use ambient temperature and light levels should remain as constant as possible.
2. If required adherence to Standard Operating Procedures (SOP) and Good Laboratory Practice (GLP) should be monitored with regular calibration checks and a suitable Quality Control (QC) programme.
3. The sample chamber lid must be fully closed during measurement and before any readings are recorded or printed.
4. The correct selection of sample containers is imperative for accurate and reproducible results:
 - a) Check that the material of the sample container is compatible with the wavelengths to be used for measurement. In general glass can only be used down to 360nm or 320nm depending on quality. Standard plastic cuvettes can be used down to 320nm. Special UV versions can be used down to 260nm. Below this level quartz cuvettes must be used.
 - b) Plastic disposable cuvettes should only be used ONCE.
 - c) Glass cuvettes should be thoroughly cleaned after use. Discard when scratches become evident on optical surfaces.
 - d) Care should be taken when selecting semi-micro or micro cuvettes. The cuvette window on the inner chamber (the area filled with sample) must be wider than the aperture in the sample holder or light will reach the detector without passing through the sample. In this case, semi-micro or micro cuvettes with self-screening black surrounds must be used or, alternative holders for these cuvettes should be used.
 - e) Glass test tubes and other sample tubes should be used with care. Where possible, matched tubes should be used and any index mark set to the correct position before measurements are made.
 - f) Ensure any sample containers used are compatible with the constituents of both the samples and standards they are to hold. Plastic cuvettes are not compatible with organic solvents.
 - g) All sample containers must be handled with care; by the top, bottom and non-optical surfaces only. Any finger marks evident must be removed by a suitable cleaning process.
 - h) Flow-through cuvettes must be selected with care and consideration for the sample type, sample volume, pumping system, rinse, sample and waste handling to be used.

5. Samples and standards should not be stored in open cuvettes or sample containers as evaporation will change the value and lead to staining of the walls which may be irreversible. If stored in stoppered and sealed cuvettes, they should be filled with little or no air space and the values regularly checked against a reference standard or quality control material.
6. Samples should be allowed to equilibrate to ambient temperature before measurement (unless a suitable temperature controlled sample holder is in use). Temperature change during measurement may cause air bubbles to form on the walls of the sample holder. This is a common cause of drift during measurement.
7. In the preparation of samples and standards high grade borosilicate glass and AR grade chemicals and reagents must be used. Good quality deionised water or other suitable solvents must be used for dissolving or diluting samples, chemicals and reagents.
8. All measurements require calibration to a blank, for maximum accuracy this should be prepared with care using the same deionised water or solvent used for dissolving or diluting the sample. Where reagents are added to the sample to produce a colour proportional to its concentration a 'sample based' blank should be used. In this case the blank should consist of all reagents or chemicals to be used, **except** the sample which will produce the colour to be measured.
9. Deviations from the Beer-Lambert Law may occur at high and low concentrations giving non-linear response during sample concentration measurements. For all new methods a linear range should be defined by the preparation of a calibration curve.
10. Cuvettes and sample holders must be filled to a minimum level which covers the light path. All Jenway spectrophotometers have a beam height of 15mm.
11. The instrument must be calibrated to zero absorbance/100% transmittance prior to taking readings.

SECTION 4 – Instrument Setup

4.1 NAVIGATING AND SCREEN SETUP

The main menu screen is displayed below.

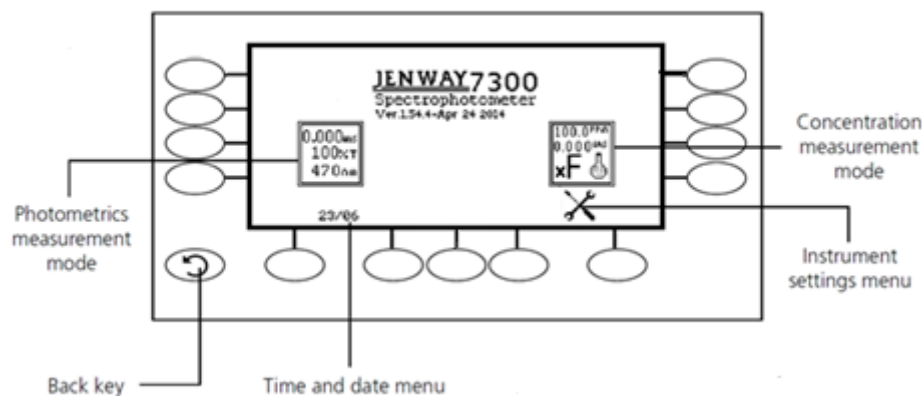
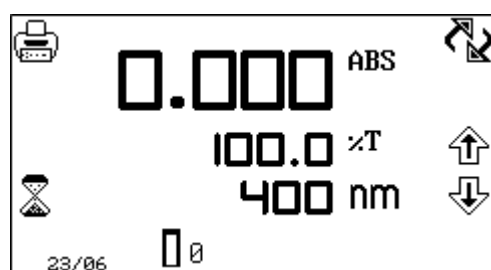

Fig 4.1 – Home Screen

To navigate around the spectrophotometer screen press the soft keys adjacent to icons displayed on the screen. In the main menu either of the two soft keys adjacent to the measurement mode icon can be pressed to access the mode. There is a back key which returns to the previous menu without saving any changes.

The main menu screen provides access to the measurement modes, the time and date menu and the instrument settings menu. The measurement modes are photometrics and concentration. The instrument settings menu enables access to the screen contrast and lamp save menus.



Operating Menu

(Photometrics measurement mode)

When a measurement mode is selected the operating menu is opened. This menu enables changes to be made to the measurement parameters and method settings. The measurement settings can be accessed through the utility toolbar displayed on the left hand side of the operating menu. This toolbar provides the same functions in all of the measurement modes. The utility toolbar enables access to printing, print setup

options and autologging options. For more details on the different functions of the utility toolbar refer to section 7.

4.2 TIME AND DATE

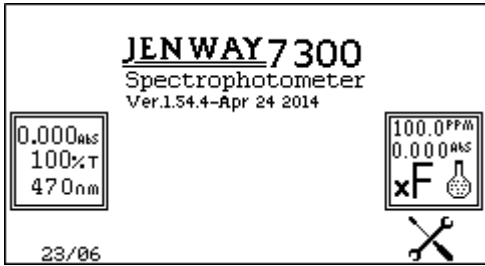

The time and date menu enables the current time and date to be set. This information will be saved on all results and displayed on printouts. The time and date menu can be accessed from the main menu by holding the key below the time and date icon for 2 seconds. Pressing the key once cycles the display between time and date.

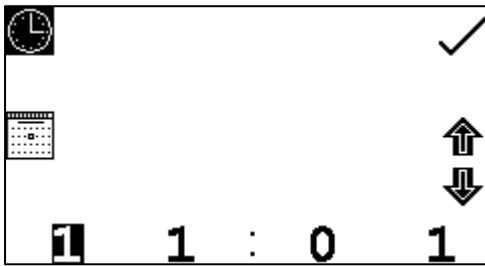

In the time and date menu to set the time press the key adjacent to the clock icon. Select the digit to be changed using the keys at the bottom of the screen. Use the keys adjacent to the arrow icons to increase or decrease the number. The clock function uses a 24 hour format.

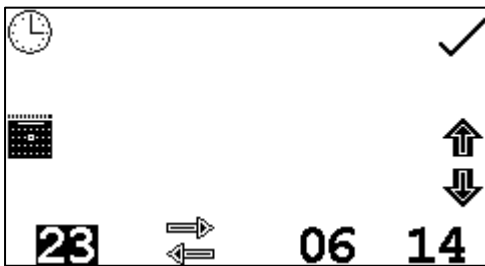

In the time and date menu to set the date press the key adjacent to the calendar icon. Select the digit to be changed using the keys at the bottom of the screen. Use the keys adjacent to the arrow icons to increase or decrease the number. The date format can be displayed as either European dd/mm/yy or American

mm/dd/yy. To change between the two formats press the key below the toggle icon. Once the current time and date have been set press the key adjacent to the tick icon to save the changes. To exit this menu without saving any changes press the back key and the screen will return to the main menu.

4.3 INSTRUMENT SETTINGS MENU

The instrument settings menu is accessed by pressing the key below the instrument settings icon in the main menu. This menu enables access to screen contrast and lamp save menus. The tick icon saves any changes made and returns to the main menu.

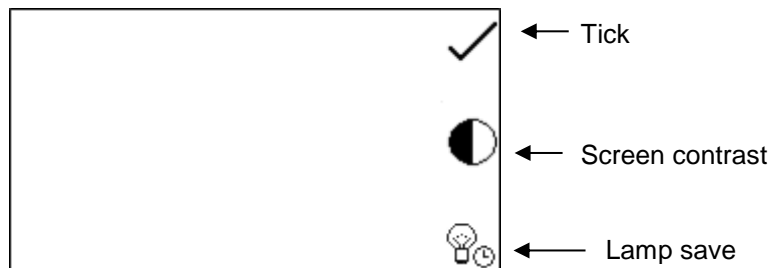
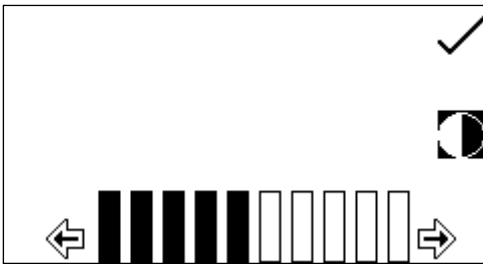

Fig 4.3 - Settings Menu

4.4 SCREEN CONTRAST



The screen contrast function enables the brightness of the screen to be set. In the instrument settings menu press the key adjacent to the screen contrast icon. Use the keys below the arrow icons to increase or decrease the screen contrast. Once the required brightness level has been reached press the key adjacent to the tick icon to save and return to the instrument settings menu.

4.5 LAMP SAVE

This function is only available on the 7300 visible spectrophotometer which uses a tungsten halogen lamp.



The lamp save function enables the time in minutes to be set after which the lamp will be turned off following a period of no lamp activity, i.e. no readings have been performed. This function is accessed through the instrument settings menu by pressing the key adjacent to the lamp save icon.

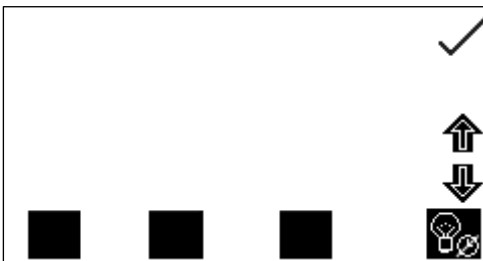

When this menu is first accessed the lamp save is turned off. To activate the lamp save function press the key below the lamp save icon. To deactivate the lamp save function press the key below the lamp save icon.



The default minimum time is set to 30 minutes. Select the digit to be changed using the keys at the bottom of the screen. Use the keys adjacent to the arrow icons to increase or decrease the number. Once the required time in minutes has been set press the key adjacent to the tick icon to save and return to the instrument settings menu.

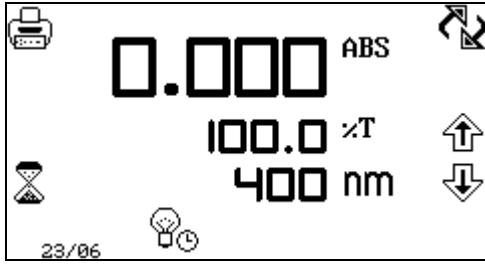

The time set will begin to count down when there is no lamp activity. When the count down is complete the lamp and the fan will be turned off and the lamp save icon is shown in all the measurement modes. To bring the instrument out of the lamp save in order to perform a measurement press the key below the lamp save icon. The lamp and fan will be turned back on and the lamp will begin to warm up.

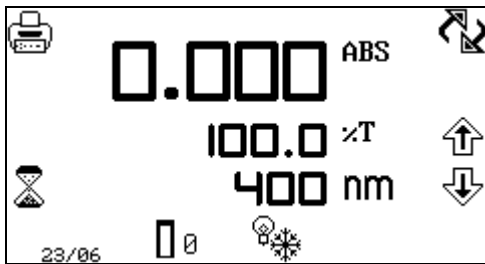

The lamp cold icon is displayed adjacent to the calibrate to zero icon in the measurement mode. The time needed for the lamp to warm up is five minutes.

Calibration and measurements can be performed whilst the lamp is warming up but these results may not be accurate.

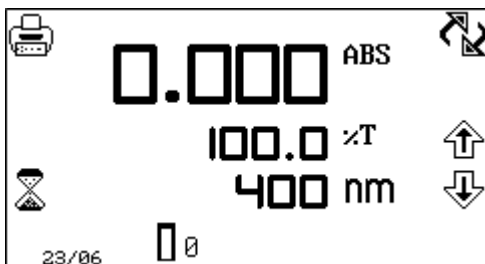

Once the warm up time of five minutes is complete the lamp cold icon disappears.

SECTION 5 – PHOTOMETRICS

The photometrics measurement mode enables simple measurements of absorbance and % transmittance to be performed. The sample is measured at one wavelength and at one point in time. There are no post measurement calculations available in this measurement mode.

5.1 MODE SPECIFIC PARAMETERS

The photometrics operating menu enables measurement parameters to be changed. The utility toolbar on the left hand side of the screen enables access to printing, print setup options and autologging options. For more details on the different functions of the utility toolbar refer to section 7.

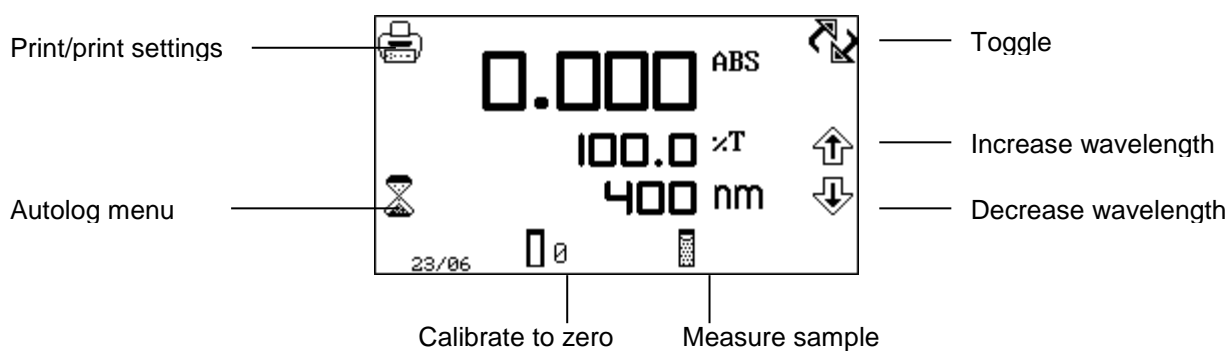
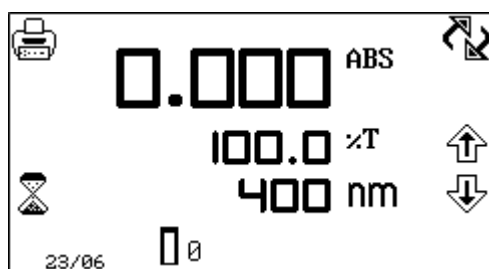

Fig 5.1 - Operating Menu

5.2 METHOD SET UP



This measurement mode is very simple and the only parameters which can be adjusted are the wavelength and the display format.

The toggle icon enables the large primary display to be set to show the absorbance or % transmittance. To change the primary and secondary displays press the key adjacent to the toggle icon. Repeat presses will cycle the displays between absorbance or % transmittance.

5.2.1 Selecting a Wavelength

The wavelength can be adjusted in the operating menu by using the keys adjacent to the arrow icons to increase or decrease the wavelength. Once the required wavelength has been selected a calibration can be performed.

5.3 CALIBRATION

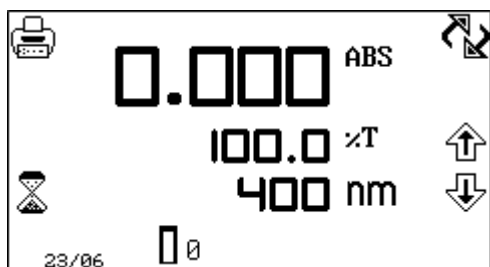

The calibration must be performed at the same wavelength at which the sample will be measured. Insert a cuvette containing the blank solution into the sample chamber and close the instrument lid. Press the key below the calibrate to zero absorbance icon. This sets the instrument to zero absorbance and 100% transmittance.

Once the calibration is complete the measure sample icon appears and the sample can be measured. If the wavelength is adjusted before a sample is measured the measure sample icon will disappear and the instrument must be calibrated again at the new wavelength.

5.4 SAMPLE MEASUREMENT

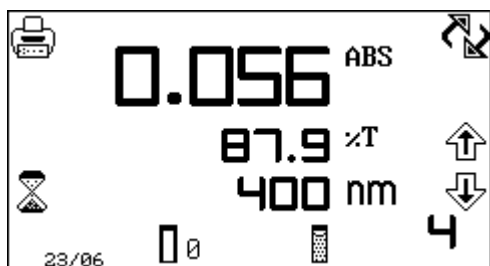

It is not possible to measure a sample before the instrument has been calibrated at the selected wavelength. Once the calibration has been performed the measure sample icon is displayed and a sample can be measured. Remove the cuvette containing the blank solution and place a cuvette containing the

sample to be measured in the sample holder. Close the instrument lid and press the key below the measure sample icon. Once the measurement is complete the photometric result will be shown on the screen.

Subsequent samples can be measured in the same way. If the wavelength is adjusted between sample measurements then the instrument must be calibrated again before more samples can be measured.

SECTION 6 – CONCENTRATION

The concentration measurement mode enables simple measurements of absorbance and concentration to be performed. In this measurement mode it is possible to calibrate against a standard of a known concentration or use a known factor. The sample is measured at one wavelength at one point in time. There are no post measurement calculations available in this measurement mode.

6.1 MODE SPECIFIC PARAMETERS

The concentration operating menu enables measurement parameters to be changed. The utility toolbar on the left hand side of the screen enables access to printing, print setup options and autologging options. For more details on the different functions of the utility toolbar refer to section 7. The settings icon enables the wavelength, units, resolution, standard or factor to be set.

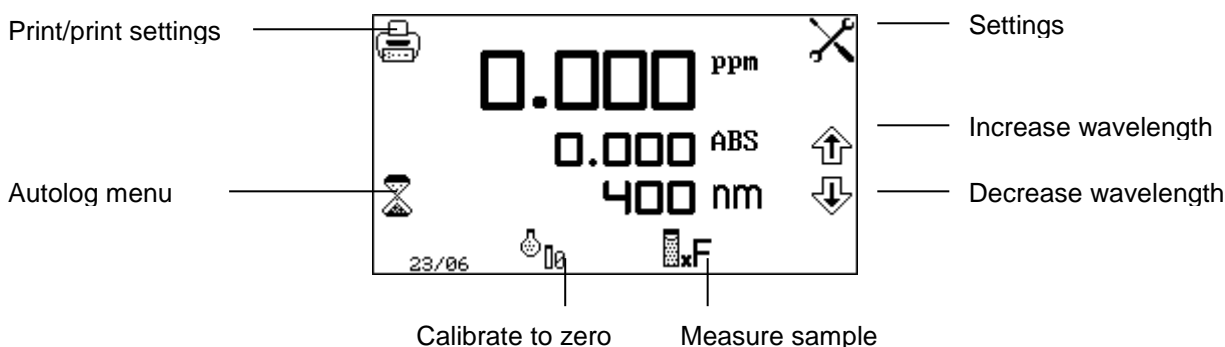
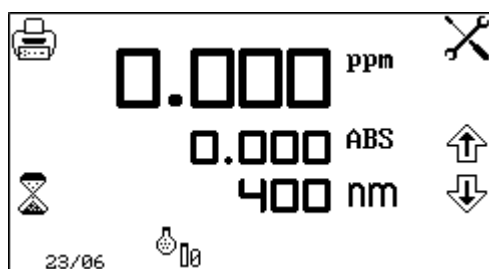

Fig 6.1 - Operating Menu

6.2 METHOD SETUP

6.2.1 Selecting a Wavelength



The wavelength can be adjusted in the operating menu or in the settings menu. To adjust the wavelength in the operating menu use the keys adjacent to the arrow icons to increase or decrease the wavelength.

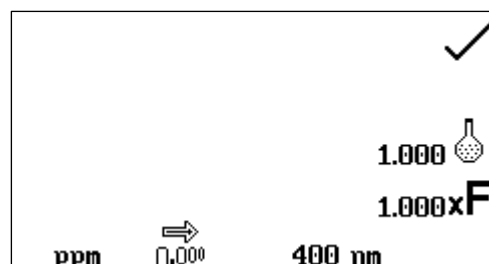

The settings menu is accessed through the operating menu by pressing the key adjacent to the settings icon. In the settings menu press the key below the wavelength icon.

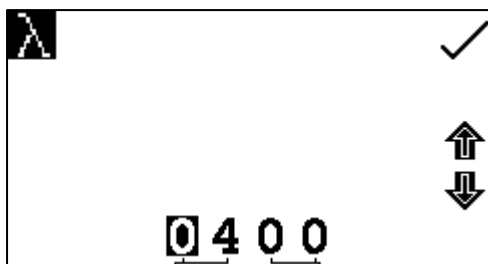

This will open a number entry screen. Use the keys at the bottom of the screen to select the digit to be adjusted. Use the keys adjacent to the arrow icons to increase or decrease the wavelength to the required number. Press the key adjacent to the tick icon to save the changes and return to the settings menu.

6.2.2 Settings

The settings menu enables the wavelength, units, resolution, standard or factor to be set and is accessed from the operating menu by pressing the key adjacent to the settings icon. Once all of the required settings have been entered press the key adjacent to the tick icon to save and return to the operating menu.

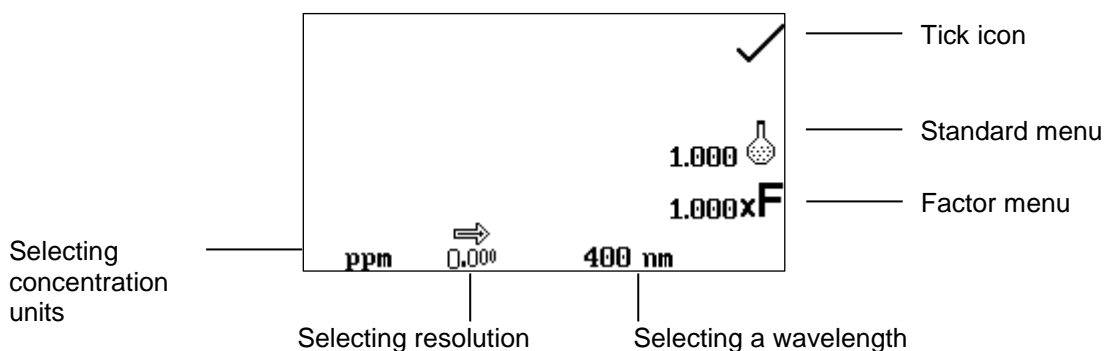
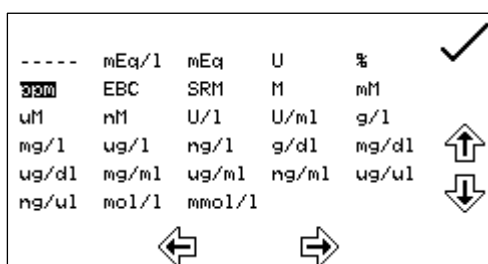

Fig 6.2.2 – Settings Menu

When setting the method parameters either the standard or the factor should be selected. The standard should be used if the factor is not known as selecting this option will calculate the factor. If the factor is known it is not necessary to measure a known standard's concentration. When the standard or factor is not selected the value should be set to 1.00.

6.2.2.1 Selecting Concentration Units

The units of concentration can be selected from a number of options: no units, %, ppm, EBC, SRM, mEq/l, mEq, M, mM, μ M, nM, U, U/l, U/ml, g/l, mg/l, μ g/l, ng/l, g/dl, mg/dl, μ g/dl, mg/ml, μ g/ml, ng/ml, μ g/ μ l, ng/ μ l, mol/l, mmol/l.



In the settings menu press the key below the units icon. This opens the unit selection screen which displays all the different units. Use the keys adjacent to the arrow icons to navigate around the screen to select the required units. Once the required units have been highlighted press the key adjacent to the tick icon to

save and return to the settings menu. The selected unit will be displayed in the minimal and operating menu along with absorbance and selected wavelength.

6.2.2.2 Changing the Resolution

The resolution that the concentration is displayed as can be selected from 1, 0.1, 0.01 or 0.001 by repeat presses of the key below the resolution icon in the settings menu.

6.2.2.3 Using a Standard

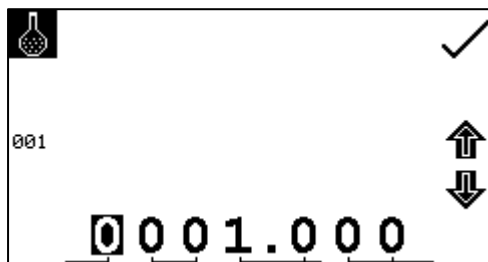

The standard menu enables the value of a standard to be entered. This function is accessed by pressing the key adjacent to the standard icon. This opens the extended number entry screen. Use the keys at the bottom of the screen to select the digit to be changed. The key below the digit must be pressed twice to select

the adjacent digit. For example 00 the first press of the key alters 10, the second press alters 01. Use the keys adjacent to the arrow icons to increase or decrease the selected number. Standard values from 0.001 to 1000 can be entered. The standard value can be reset to one by pressing the key adjacent to the 001 icon. Once the standard value has been entered press the key adjacent to the tick icon to save and return to the settings menu. The entered value is displayed in the settings menu adjacent to the standard icon.

A standard value should only be entered if the factor is not known. If the factor is known the standard value should be set to 1.000.

6.2.2.4 Using a Factor

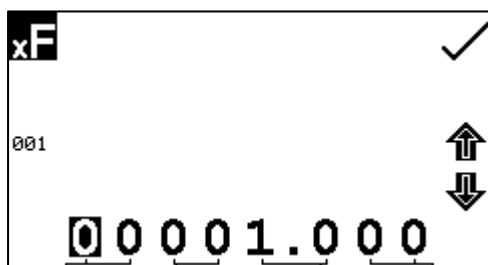

The factor menu enables a factor to be entered. This function is accessed by pressing the key adjacent to the factor icon. This opens the extended number entry screen. Use the keys at the bottom of the screen to select the digit to be changed. The key below the digit must be pressed twice to select the adjacent digit.

For example 00 the first press of the key alters 10, the second press alters 01. Use the keys adjacent to the arrow icons to increase or decrease the selected number. Factor values of 0.001 to 10,000 can be entered. The factor value can be reset to one by pressing the key adjacent to the 001 icon. Once the factor has been entered press the key adjacent to the tick icon to save and return to the settings menu. The entered value is displayed in the settings menu adjacent to the factor icon.

If the factor is not known a standard should be measured in order to calculate the factor. If a standard is used the factor value should be set to 1.000.

6.3 CALIBRATION

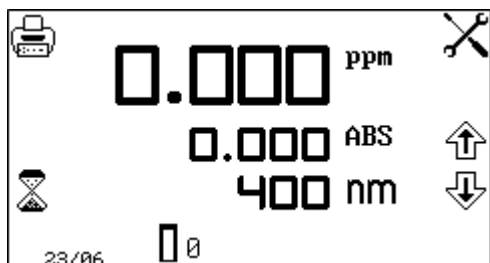

In the concentration measurement mode calibrations against a standard or a factor can be performed following a zero calibration. If the factor is not known calibration against a known standard is performed in order to calculate the factor. However if the factor is known there is no need to calibrate using a standard.

The calibration must be performed at the same wavelength at which the sample will be measured.

6.3.1 Calibrating to a Standard

Insert a cuvette containing the blank solution into the sample chamber and close the instrument lid. Press the key below the calibrate to zero absorbance icon. The instrument will calibrate to zero absorbance. Insert a cuvette containing the standard concentration sample solution into the sample chamber and close the instrument lid.

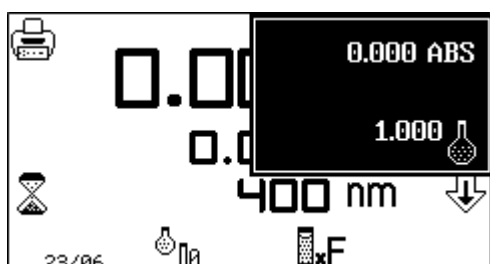

Press the key below the calibrate to zero absorbance or standard icon, this will open another menu with the option to re-calibrate to zero absorbance or to calibrate to the previously entered standard value. Press the key adjacent to the calibrate to standard icon.

If the standard selected requires a factor beyond the range of the instrument the check standard icon will be displayed.

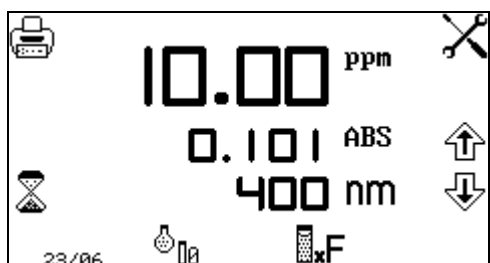

The instrument will take a reading and calibrate to the standard concentration. Once the calibration is complete the sample can be measured using the measure to standard icon.

6.3.2 Calibrating to a Factor

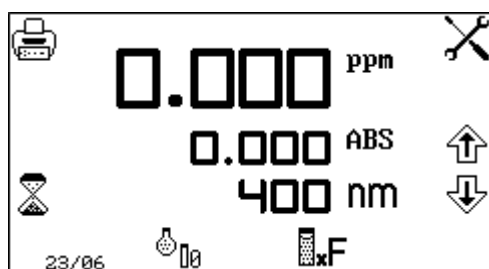

Insert a cuvette containing the blank solution into the sample chamber and close the instrument lid. Press the key below the calibrate to zero absorbance icon. The instrument will calibrate to zero absorbance. Once the calibration is complete the sample can be measured using the measure to factor icon.

6.4 SAMPLE MEASUREMENT

It is not possible to perform sample measurements before the instrument has been calibrated at the selected wavelength. In this operating mode the type of sample measurement performed depends on the calibration which has been carried out.

6.4.1 Measuring a Sample After Calibrating to a Standard

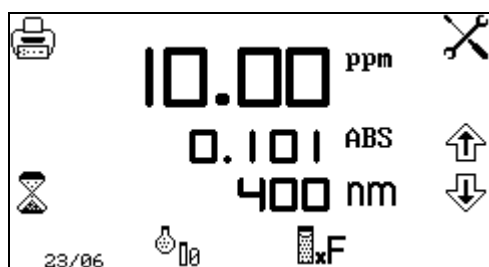

Remove the cuvette containing the standard sample and place a cuvette containing the sample to be measured in the sample chamber. Close the instrument lid and press the key below the measure to standard icon. Once the measurement is complete the concentration and absorbance values are displayed.

6.4.2 Measuring a Sample After Calibrating to a Factor

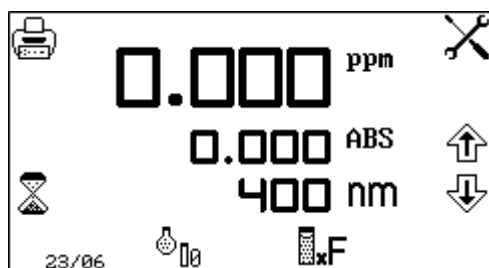

Remove the cuvette containing the blank solution and place a cuvette containing the sample to be measured in the sample chamber. Close the instrument lid and press the key below the measure to factor icon. Once the measurement is complete the concentration and absorbance values are displayed.

In order to measure a sample based on a known factor the value for the factor must be entered in the settings menu before commencing measurement of the sample.

6.5 POST MEASUREMENT OPTIONS

Post measurement changes to the selected concentration units, the concentration factor and the calibration standard values are restricted.

6.5.1 Changing Concentration Units

Users can adjust the displayed concentration unit after a measurement. If the measurements concentration unit is updated, the instrument will adjust the displayed concentration value to reflect the new selection. This functionality is limited to ensure that the user can only update the measurement unit to one that is a direct conversion from the original measurement unit. These restrictions are summarized in Table 6.5.1, where the selectable measurement units are grouped according to those which are interchangeable after a measurement.

Interchangeable Measurement Units								
1	2	3	4	5	6	7	8	9
%	EBC	mEq/l	mEq	M	U	U/l	g/l	mol/l
ppm	SRM			mM		U/ml	mg/l	mmol/l
				uM			ug/l	
				nM			ng/l	
							g/dl	
							mg/dl	
							ug/dl	
							mg/ml	
							ug/ml	
							ng/ml	
							ug/ul	
							ng/ul	

Table 6.5.1 – Post Measurement Unit Change Restrictions



Once a measurement is complete, press the key adjacent to the settings icon, then press the key below the units icon. This will either cycle through the available unit options or open the units selection page.

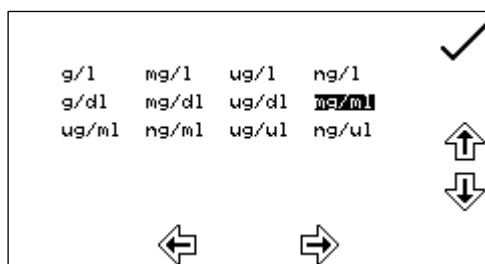

In the units selection page, select the updated measurement unit from the available options and press the key adjacent to the tick icon to confirm.

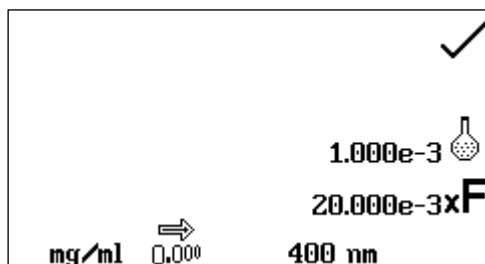

In the concentration settings menu, the calibration standard and concentration factor values are updated.

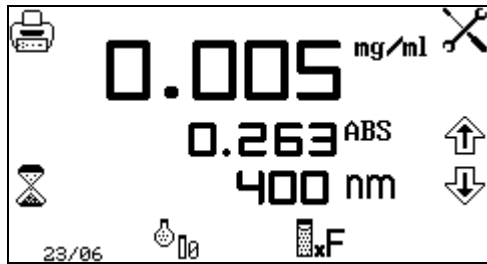

The updated concentration value and unit are shown in the main display.

6.5.2 Changing the Concentration Factor

Users cannot adjust the concentration factor once a blank measurement is performed. If the concentration factor needs to be changed, the user must exit and re-enter the concentration measurement mode.

6.5.3 Changing the Calibration Standard Value

Users cannot adjust the calibration standard value once a blank measurement is performed. If the calibration standard value needs to be changed, the user must exit and re-enter the concentration measurement mode.

SECTION 7 – PRINTING AND AUTOLOGGING

The utility toolbar in the operating menu provides access to printing, print setup options, and autologging options.

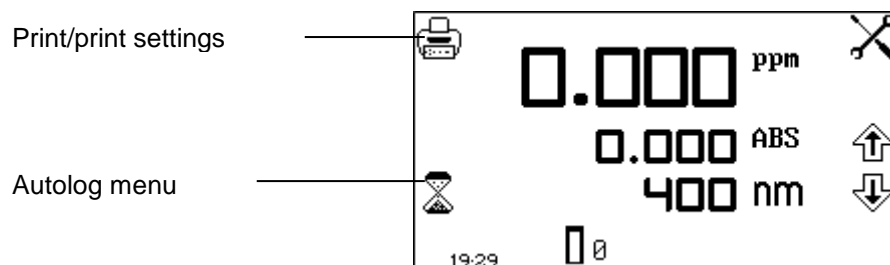
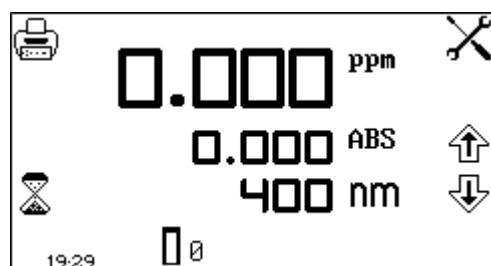

Fig 7.1 - Operating Menu

7.1 PRINTING



Operating Menu

The utility toolbar in the operating menu enables results to be printed and print setup options to be set. The print setup menu enables the destination of the printouts and language of the printouts to be set.

7.1.1 Print Setup

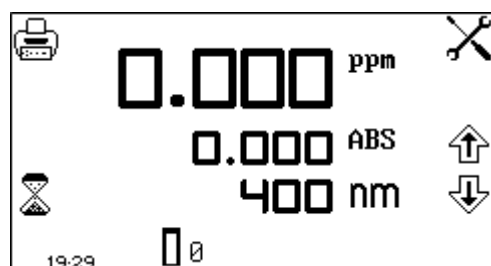

To open the print setup menu hold the key adjacent to the printer icon for 2 seconds in the operating menu.



To select the language for the printouts press the key adjacent to English icon. Repeat pressing of the key cycles the language between English, Français, Deutsche, Espânôl and Italiano.

The destination of the printouts can be the internal printer or an external serial printer. The results can only be sent to an external serial printer if there is a serial printer connected to the instrument via the RS232 serial port. Press the key adjacent to the computer icon to select the external

printer. The results can only be sent to the internal printer if there is an internal printer connected. To select the internal printer for the printout destination press the key adjacent to the printer icon.

Once the required printout destination and language has been selected press the key adjacent to the tick icon to save and return to the operating menu.

7.1.2 Printing Results

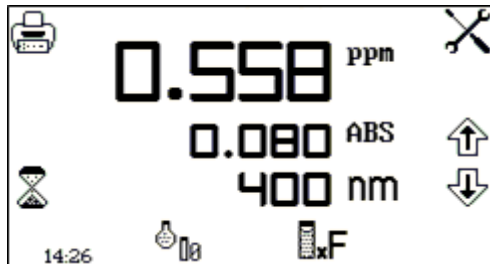

Results displayed in the operating menu can be printed by pressing the key adjacent to the printer icon. Depending on the printout destination previously selected the result will be sent to the internal printer or the external printer. If the printer icon is pressed when there is not a result on the screen the

no result to printer or no result to RS232 icon (depending on results destination) will flash up on the screen.

7.2 AUTOLOGGING

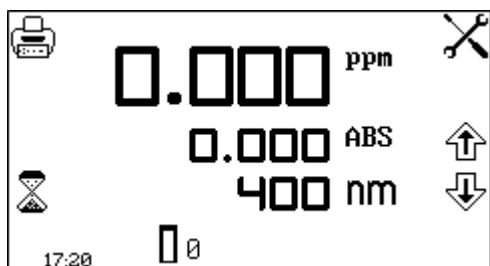

Operating Menu

The autolog function enables repeat measurements of the same sample to be performed with a set time period between each measurement. This produces a batch of results for the same sample. The autolog function also enables the results to be autologged to different destinations. The autolog menu is accessed from the utility toolbar in the operating menu by pressing the key adjacent to the autolog icon.

7.2.1 Setting the Number of Sample Repetitions

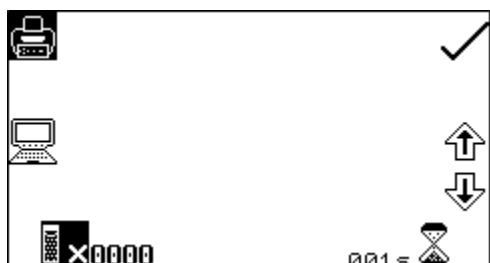

To set the number of repeat measurements of the same sample press the key below the sample icon and use the keys adjacent to the arrow icons to increase or decrease the number of repetitions required. To reset the number to zero press and hold the key below the sample icon for 2 seconds.

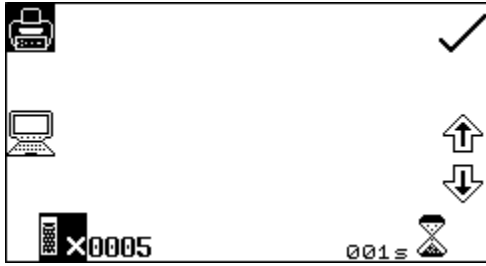

To set the time period between each measurement press the key below the timer icon and use the keys adjacent to the arrow icons to increase or decrease the time in 1 second intervals. To reset the time to one second press and hold the key below the timer icon for 2 seconds.

Once the required number of repetitions and time interval have been selected press the key adjacent to the tick icon to save the changes and return to the operating menu.

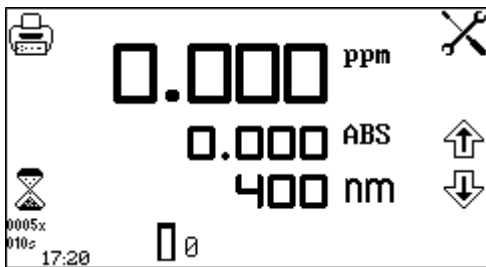

The number of repetitions and time period will be displayed below the autolog icon. To commence autologging press the key below the measure sample icon. Once the first measurement has been performed the time period starts counting down until it reaches zero and then the next measurement will be taken.

This will reduce the repetition number by one. When the number of repetitions reaches zero, autologging is complete. Autologging can be stopped before all the measurements have been completed by pressing the key adjacent to the autolog icon. Confirmation will be needed to stop autologging. Press the key adjacent to the tick icon to confirm stopping autologging or press the key adjacent to the cross icon to continue autologging.

7.2.2 Selecting Result's Destination

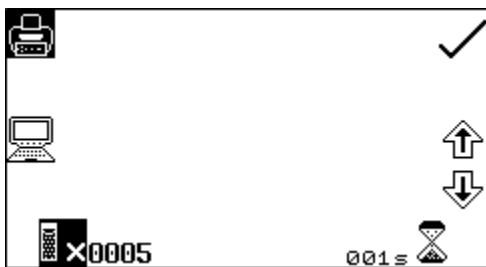

The autolog menu enables the result's destination to be set. To select the internal printer press the key adjacent to the printer icon. This option is only available if an internal printer is connected. To send the results to an external instrument such as a PC or a serial printer press the key adjacent to the computer icon.

7.3 CONNECTING TO A PC

Connect the interface cable to the RS232 serial port on the rear of the instrument and connect to the serial port on the rear of the PC. Turn the PC on and load the PC software by inserting the PC software disc into the CD drive. If the PC software does not auto run open My Computer and double click on the Jenway 73 series software icon. Follow the instructions to install the PC software to the required location. Refer to the PC software manual for further instructions. Once the software is installed, turn the mains power on to the instrument.

The PC software is pre-configured to run using the following settings:

9600 baud

8 data bits

No parity

1 stop bit

SECTION 8 – Accessories and Spare Parts

8.1 OPTIONAL ACCESSORIES

Part Code	Description of Accessory
660 101	Internal printer
735 401	Automatic 8 cell turret
735 201	Sipper pump
735 301	Peltier
735 701	Combined sipper Peltier pump
735 801	10x10mm path length cuvette holder
735 901	16/24mm test tube holder
736 001	10x100mm path length cuvette holder
736 101	10x10mm path length micro-cuvette holder
736 201	Water heated 10x10 single cell holder
035 088	Visible calibration set
035 091	UV/Visible calibration set
060 422	Moulded cuvette rack for 16 10x10mm cuvettes
735 001	Dust cover
019 146	4GB USB memory sticks for external memory
037 551	RS232 to USB converter for use with computer without a serial port

8.2 CONNECTING THE ACCESSORIES

There are two types of accessories which can be fitted in the sample chamber – passive or active accessories. The range of passive accessories includes 10 x 10mm single cuvette holders, single water heated cuvette holders, adjustable path length (10 to 100 mm) cuvette holders, test tube holders, boiling tube holders and micro-cuvette holders. The range of active accessories includes an automated 8 cell changer, sipper pump, Peltier and combined sipper Peltier pump. The instrument must be turned off before any accessories are fitted.

8.2.1 Internal Printer

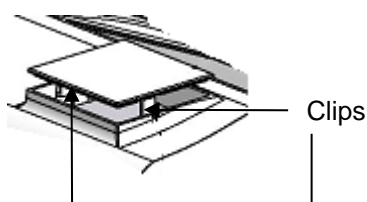

Use a small screw driver to lift the blanking panel on the top of the instrument. Squeeze the two clips in order to remove the blanking panel. Disconnect the printer wires which are secured to the underside of the blanking plate.

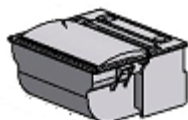

Unpack the printer from the packaging. Turn the printer upside down and connect the printer wires by clipping into the connector on the printer.

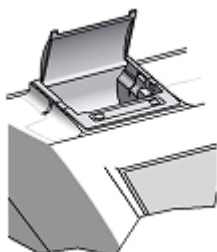

Squeeze the grey plastic clips together so that the printer top opens. Slot the printer into the top of the instrument and push down until it fits flush to all four sides.

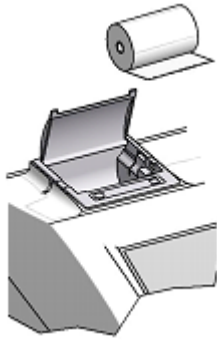

Insert the paper roll into the printer – ensuring that there is some paper sticking out of the printer before clicking the grey plastic back into place. Switch the instrument on. The power and error lights on the printer will flash. Once the instrument power on tests are complete press the feed button to check that the paper is fed correctly.

8.2.2 Passive Accessories

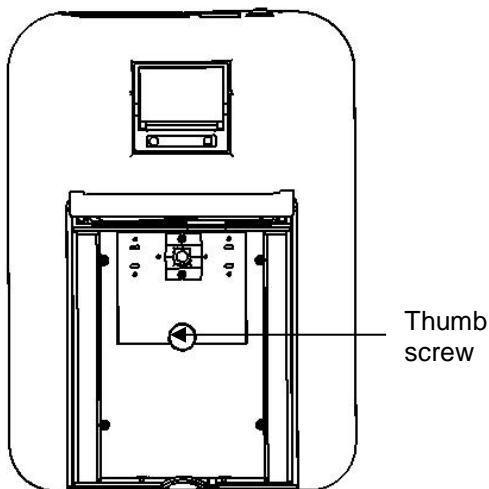

Unscrew the thumb screw to undo the passive accessory. Lift out the passive accessory. To fit a different passive accessory simply place the accessory in the correct orientation, align the thumb screw and tighten to fix in place.

To replace the passive accessory with an active accessory refer to section 8.2.3.

8.2.2.1 Water-heated cuvette holder

The water heated cuvette holder is supplied with an additional front panel which also needs to be fitted.

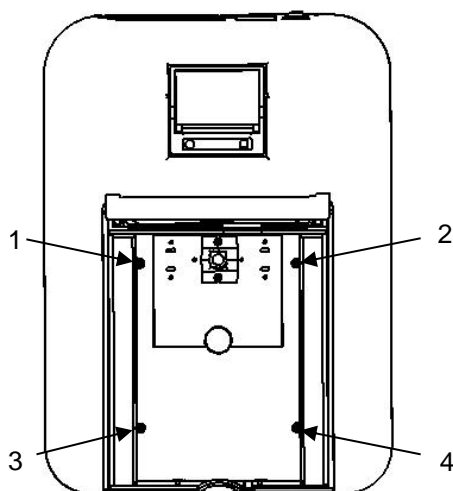

The water heated cuvette holder is already fitted to a base plate so the base plate in the instrument must be removed before installation. Unscrew screws 1 to 4 and lift out the metal base plate.

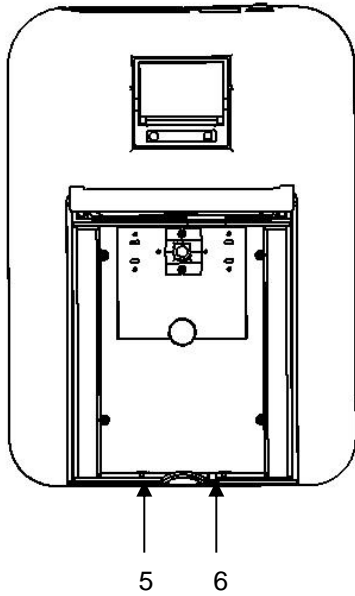

For this accessory as well as removing the passive accessory base plate, the front panel of the instrument must also be removed. Loosen screws 5 and 6 until the front panel can be lifted out in the forwards direction.

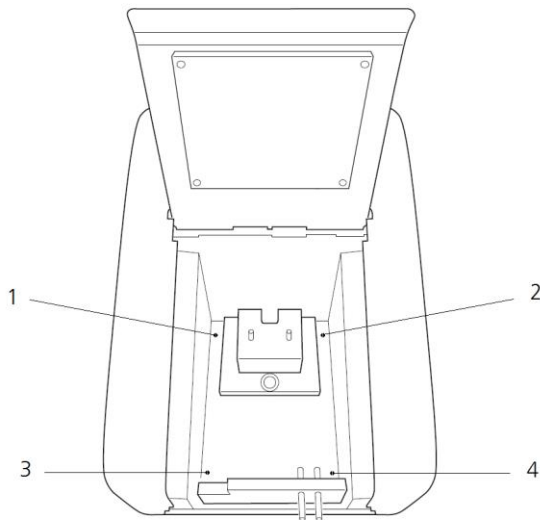

Once the base plate and front panel have been removed insert the water-heated cuvette holder into the chamber, ensuring the base plate rests flat in the unit. Replace the screws 1 to 4, securing the accessory in place.

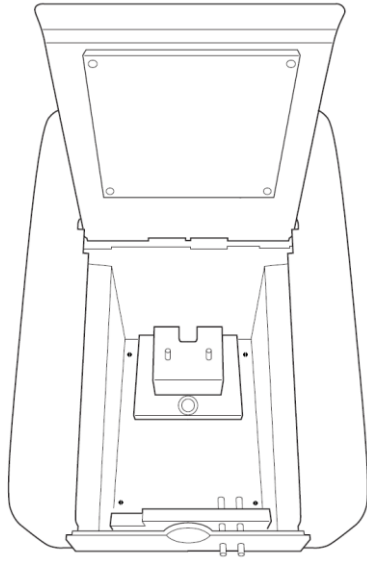

Fit the custom front panel to the unit ensuring the metal pipes on the accessory are aligned and fed through the two holes in the front panel. The metal pipes should protrude from the outer casing. Secure the custom accessory front plate to the unit with screws 5 and 6.

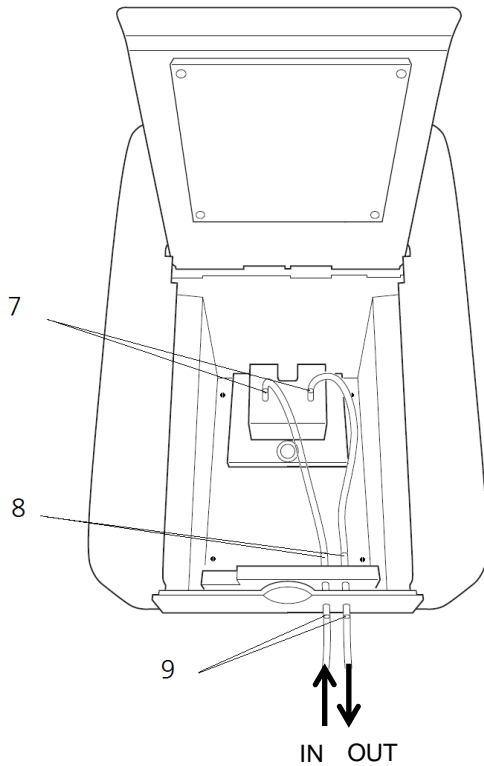

From the rubber tubing supplied, cut two shorter lengths of tubing and use these to connect the internal metal pipes of the cell block (7) to the internal metal pipes on the outer casing (8).

Using two separate pieces of rubber tubing connect the two external metal tubes (9) to an external water bath and pump. Ensure the water is pumped in through the left and out through the right hand side of the cell block.

All tubing must be kept as short as possible and the tubing must not be allowed to obstruct the light path.

8.2.3 Active Accessories

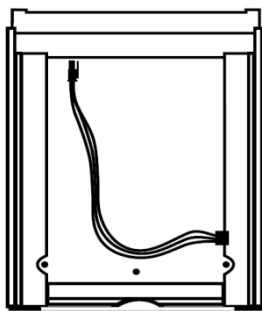
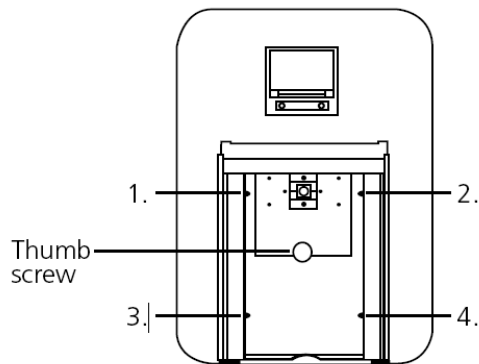

Unscrew the thumb screw to undo the passive accessory. Lift out the passive accessory. To fit an active accessory unscrew screws 1 to 4 and lift out the metal base plate.

This will expose the bottom of the sample chamber with the power supply connection needed to operate the active accessories.

8.2.3.1 Automatic 8 cell turret

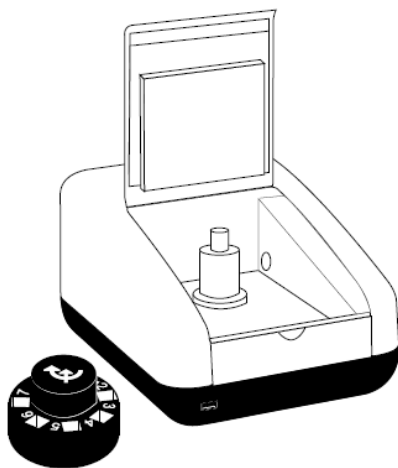
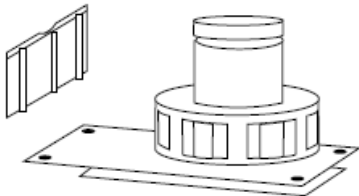

Take the 8 cell turret base plate. Connect the power supply in the bottom of the sample chamber to the connector on the underside of the base plate. Place the base plate in the sample chamber. Replace screws 1 to 4.

Take the 8 cell carousel and place on top of the motor, taking care to align the three ball bearings with the grooves on the motor shaft. Gently push the carousel down onto the motor shaft until it is located into place. Gently rotate the carousel until there is some resistance. The carousel is now in the correct position.

If the fitting is too tight use a small screw driver to loosen the ball bearings before pushing the carousel down onto the shaft.

8.2.3.2 Peltier

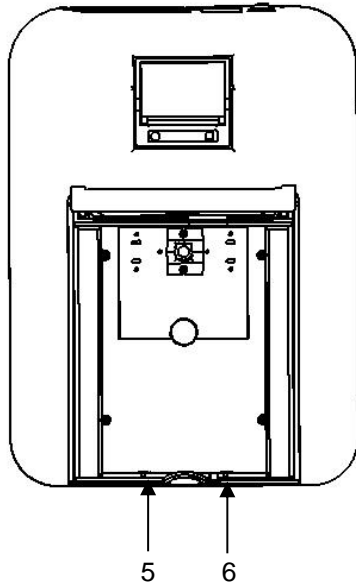

For this accessory as well as removing the passive accessory base plate, the front panel of the instrument must also be removed. Loosen screws 5 and 6 until the front panel can be lifted out in the forwards direction.

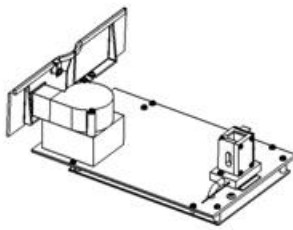

Take the Peltier base plate. Connect the power supply in the bottom of the sample chamber to the connector on the underside of the base plate. Place the base plate in the sample chamber. Replace screws 1 to 4. Take the Peltier front panel and slot into place before retightening screws 5 and 6.

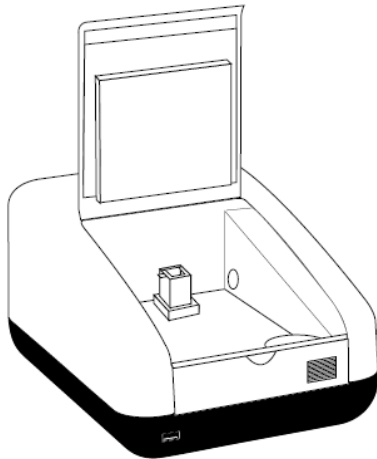

When the accessory is fitted the instrument will look like this.

8.2.3.3 Sipper pump

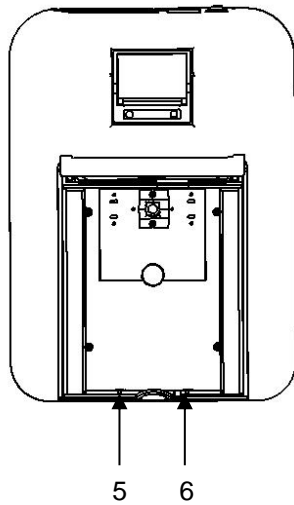

For this accessory as well as removing the passive accessory base plate, the front panel of the instrument must also be removed. Loosen screws 5 and 6 until the front panel can be lifted out in the forwards direction.

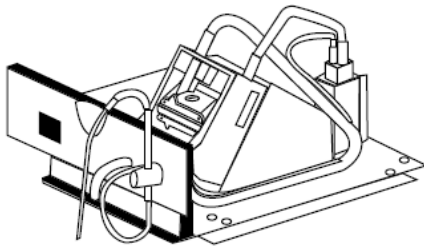

Take the sipper base plate. Connect the power supply in the bottom of the sample chamber to the connector on the underside of the base plate. Place the base plate in the sample chamber. Replace screws 1 to 4. Take the sipper Peltier front panel and slot into place before retightening screws 5 and 6.

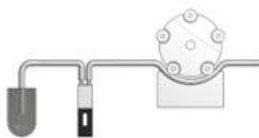

Bi directional flow A
(sipping)

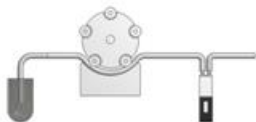

Bi directional flow B
(pumping)



Continuous flow

The tubing should be connected depending on the function that the sipper pump is going to perform. All tubing must be kept as short as possible and the tubing must not be allowed to obstruct the light path.

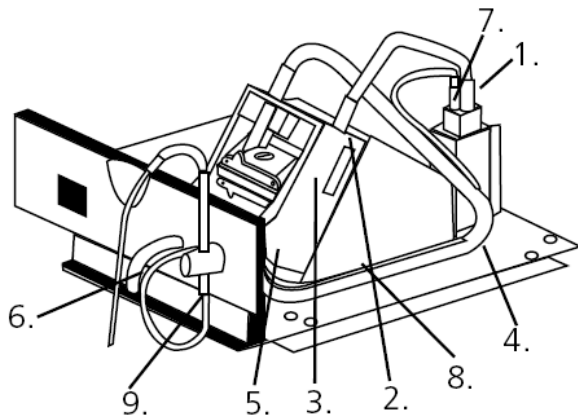

For sipping:

1. Connect the sipper pump tubing to the outlet port on the flow-through cuvette.
2. Secure the tubing using the clip on the righthand side of the pump head.
3. Ease the tubing round the rollers by carefully rotating them clockwise, by hand. Clamp the tubing into the clip on the left hand side of the motor.

4. Once secured, ensure the tubing is routed into the two retaining clips located on the base plate at the side of the pump head.
5. Cut the tubing at the point where it fits comfortably onto the left hand tube located on the inside of the front bulk head.
6. Connect a suitable length of this tubing to the external waste pipe.
7. Cut a small length of the sipper pump tube and push this over one end of the capillary tube. Connect this to the inlet port of the flow-through cuvette.
8. Route the tube into the two retaining clips located on the base plate at the side of the pump head.
9. Fit the sipper probe and secure using the thumbscrew. Feed the capillary tubing through the tube and up through the sipper probe, allowing sufficient length for it to pass into a suitable receptacle.

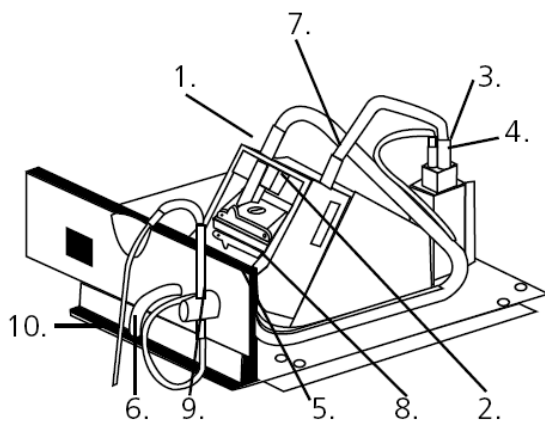

For pumping:

1. Cut two pieces of sipper pump tubing approximately 300mm in length. Take one length of tubing and fit this to the pump head, as shown, securing the tubing using the clip on the right hand side of the pump head.
2. Ease the tubing round the rollers carefully rotating them clockwise, by hand. Clamp the tubing into the clip on the left hand side of the motor.
3. Fit the other end onto the inlet port on the flow-through cuvette.

4. Fit the second 300mm length of tubing to the outlet port of the flow-through cuvette. Once secured, ensure the tubing is routed into the two retaining clips located on the base plate at the side of the pump head.

5. Fit the other end of the tubing onto the outlet port, located on the inside of the front bulkhead.
6. Connect a suitable length of sipper pump tubing to the external outlet port.
7. Insert one end of the capillary tube into the sipper pump tubing, as shown.
8. Feed the other end through the inlet port located on the inside of the bulkhead.
9. Fit the sipper probe and secure using the thumbscrew.
10. Carefully feed the tubing through the sipper probe, allowing sufficient length for it to pass into a suitable receptacle.

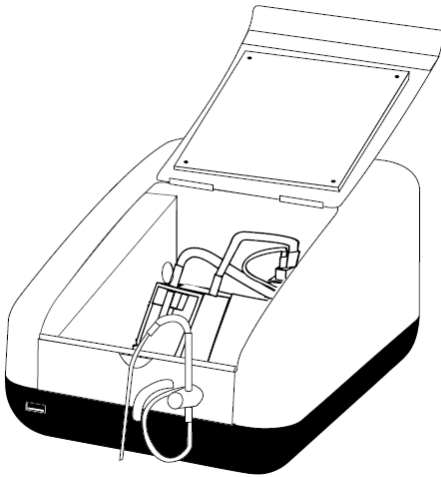

When the sipper accessory has been fitted and the tubing has been connected the instrument will look like this.

8.2.3.4 Combined sipper Peltier pump

Refer to section 8.2.3.3 for more details.

8.3 USING THE ACCESSORIES

8.3.1 Automatic 8 cell turret

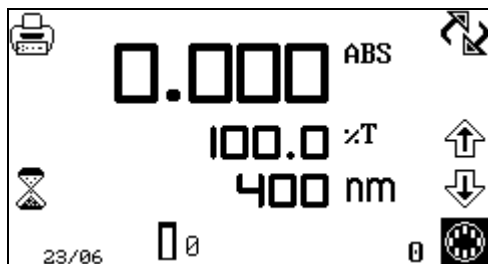

When the automatic 8 cell turret is in use the 8 cell turret icon is displayed in the bottom right hand corner of the screen. The current cell position is displayed adjacent to the 8 cell turret icon. The 0 position should always be used for the zero calibration blank sample.

To perform measurements using the automatic 8 cell turret, insert the cuvettes containing the samples into turret positions 1 to 7. Insert the cuvette containing the blank solution into turret position 0. Enter the required measurement mode and set up the required measurement parameters. Press the key below the calibrate to zero icon. The instrument will automatically move the turret around to position zero to perform the measurement. Once the calibration is complete the measure sample icon will appear and the turret will return to its original starting position.

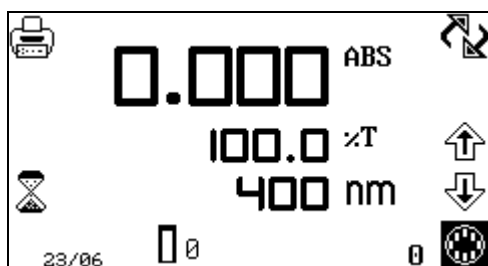

Press the key below the 8 cell turret icon to highlight the icon and the two arrow icons above. Press the keys adjacent to the arrow icons to increase or decrease the current cell position of the turret, until the required sample position has been selected. Press the key below the measure sample icon. The instrument will

perform a reading and display the result on the screen. To measure the next sample select the next turret position and press the key below the measure sample icon. Repeat this process until all the samples have been measured. To adjust the wavelength press the key below the 8 cell turret icon and use the arrow icons to adjust the wavelength.

8.3.2 Peltier

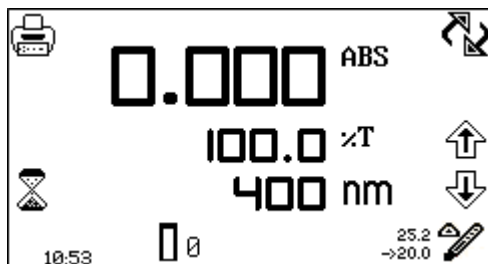

When the Peltier is in use the Peltier icon is displayed in the bottom right hand corner of the screen. The current temperature is displayed above the set point temperature adjacent to the Peltier icon. An arrow icon is displayed above or below the Peltier icon depending on if the current temperature is above or below the set temperature.

To adjust the set point temperature hold the key below the Peltier icon for 2 seconds.

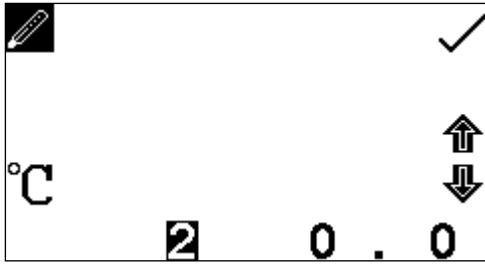

This opens the Peltier settings screen. Use the keys at the bottom of the screen to select the digit to be changed and use the arrow icons to increase or decrease the number. The temperature can be set in °C or °F by pressing the key adjacent to the °C icon.

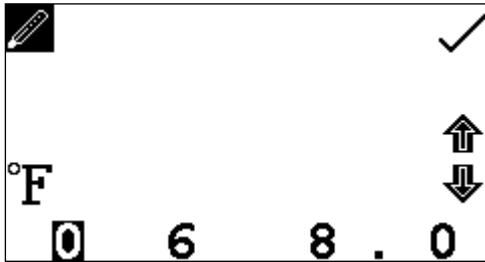

Repeat presses will cycle between °C and °F. Once the required temperature has been selected press the key adjacent to the tick icon to save and return to the operating menu. The Peltier will begin to heat or cool depending on the current temperature.

8.3.3 Sipper pump

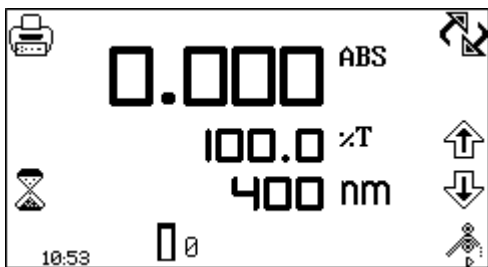

When the sipper is in use the sipper pump icon is displayed in the bottom right hand corner of the screen. The sipper pump can operate in manual or timed mode, depending on the option selected in sipper pump settings. If the manual mode is selected an arrow icon indicating pump direction will be displayed below the sipper pump icon.

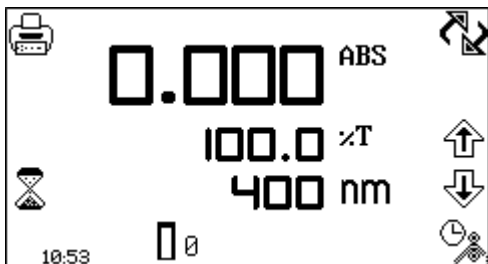

If the time mode is selected a clock icon will be displayed adjacent to the sipper pump icon.

To open the sipper pump settings hold the key below the sipper pump icon for 2 seconds.

8.3.3.1 Manual Sipper Pump Settings

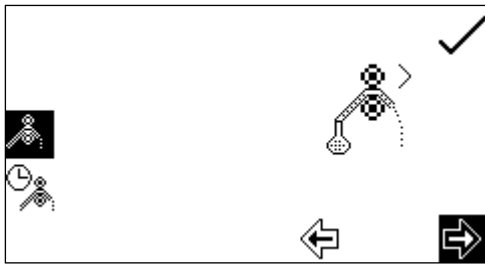

To operate the sipper pump in manual mode press the key adjacent to the manual sipper icon. Select the preferred pump direction by pressing the key below the forwards or backwards arrow. Press the key adjacent to the tick icon to save and return to the operating menu.

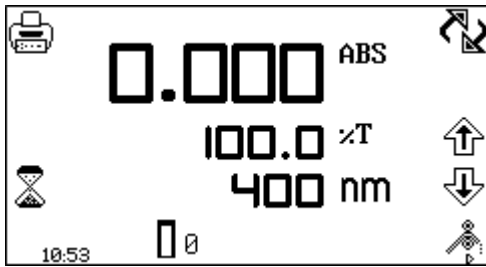

To perform a measurement place the sipper tubing into the sample and press the key below the sipper pump icon.

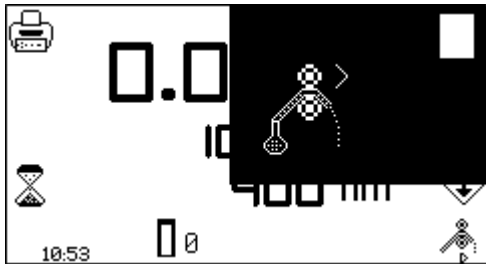

Confirmation will be needed to start the sipper pump. Press the key adjacent to the tick icon to confirm and start the sipper pump. Press the key adjacent to the cross icon to cancel and return to the operating menu.

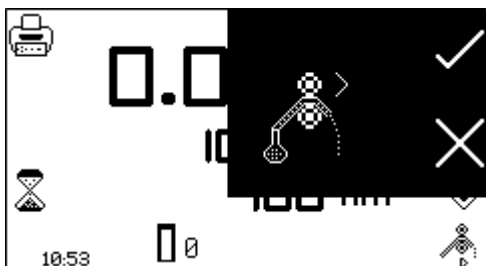

To stop the sipper pump press the key adjacent to the stop icon. Ensure that the flow through cuvette contains enough sample before pressing the key below the measure sample icon.

8.3.3.2 Timed Sipper Pump Settings

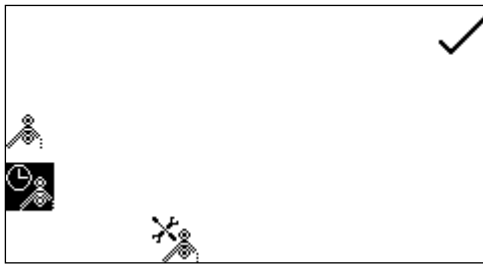

To operate the sipper pump in timed mode press the key adjacent to the timed sipper pump icon.

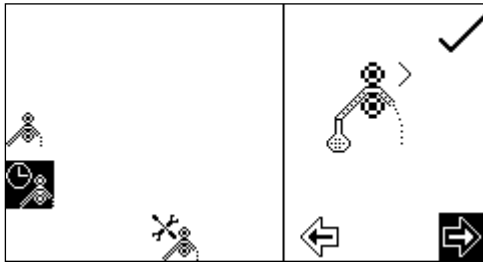

Press the key below the calibrate timed sipper icon. Select the required pump direction by pressing the key below the forwards or backwards arrow. Press the key adjacent to the tick icon to continue to the next stage of the calibration sequence.

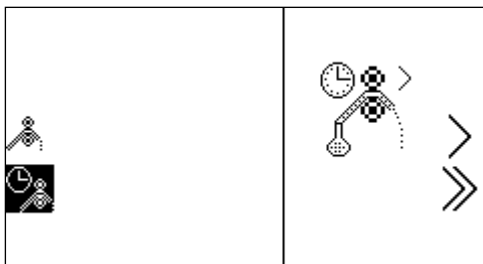

Insert the inlet tubing into the sample container and press the key adjacent to the single greater than icon. The sipper pump will start and the sample will be pumped through the tubing to the flow through cuvette. It is possible to skip this setup stage by pressing the key adjacent to the double greater than icon.

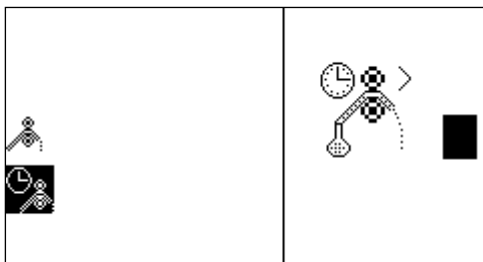

Once the cuvette is full press the key adjacent to the stop icon to stop the sipper pump. The time taken for sample uptake is recorded.

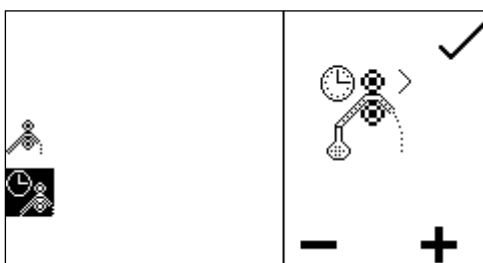

To fine tune the amount of sample uptake press the keys below the plus or minus icons to increase or decrease the amount of sample taken up. The recorded time will be adjusted accordingly. Once the fine tuning is complete, or if none is required, press the key adjacent to the tick icon to move to the next stage of the calibration sequence.

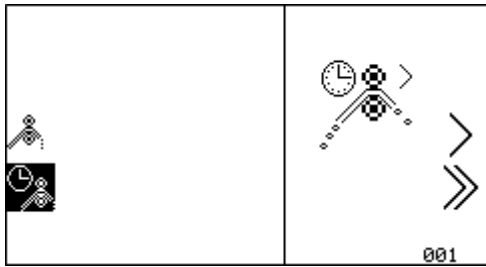

This stage allows an air gap to be added to the calibration sequence. If an air gap is not required press the key below the 001 icon to set the air gap to one. If a previously programmed air gap is to be used press the key adjacent to the double greater than icon to skip this stage and retain the current air gap time.

To program an air gap remove the inlet tubing from the sample container and press the key adjacent to the single greater than icon. The sipper pump will start and air will be pumped through the tubing to the flow through cell.

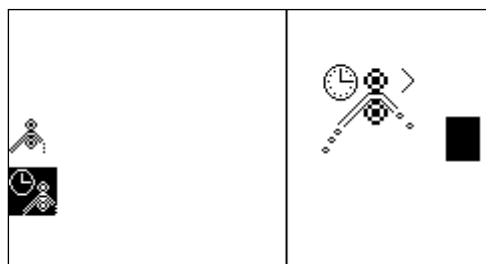

Once the required amount of air has been taken up press the key adjacent to the stop icon. The time taken for air uptake is recorded.

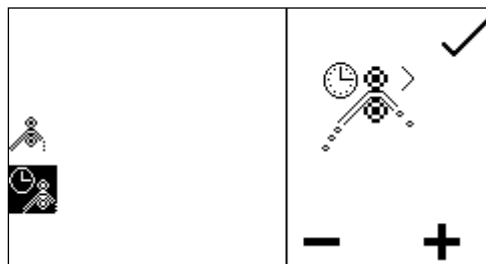

To fine tune the amount of air uptake press the keys below the plus or minus icons to increase or decrease the amount of air taken in. The recorded time will be adjusted accordingly. Once the fine tuning is complete, or if none is required press the key adjacent to the tick icon to move to the next stage of the calibration sequence.

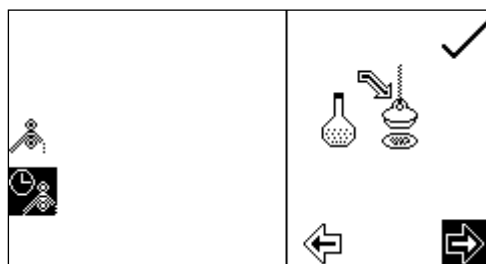

Once the sample uptake and air gap have been programmed the preferred disposal of the sample can be set. There are two options, the sample can either be sent back to the sample container or it can be sent to the waste pipe. Press the key below the forward or backward arrows to select what happens to the sample

after measurement. If the original pump direction selected was forwards, selecting the forwards direction at this stage will send the sample to waste and selecting the backwards direction will send the sample back to the sample container. Once the required direction has been selected press the key adjacent to the tick icon to save the calibration sequence and return to the operating menu. To exit the sipper calibration sequence without saving any changes press the back key at any point during the calibration sequence.

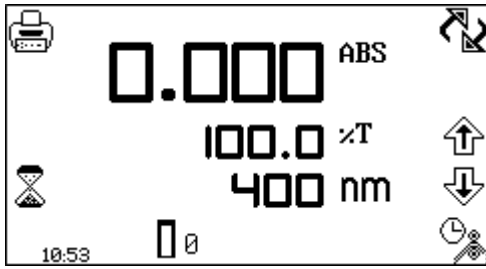

To perform a measurement place the sipper tubing into the sample and press the key below the sipper pump icon.

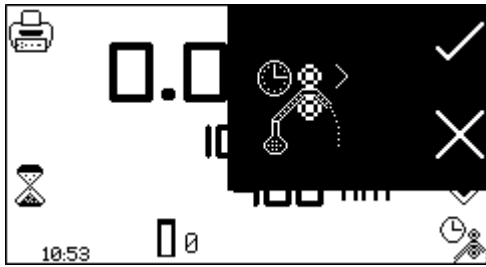

Confirmation will be needed to start the sipper pump. Press the key adjacent to the cross icon to cancel and return to the operating menu. Press the key adjacent to the tick icon to confirm and start the sipper pump. The pump will run for the previously recorded sample take up time. Ensure that the flow through

cuvette contains enough sample before pressing the key below the measure sample icon.

Once the measurement has been performed remove the tubing from the sample and press the key below the sipper pump icon to perform the next stage of the calibration sequence.

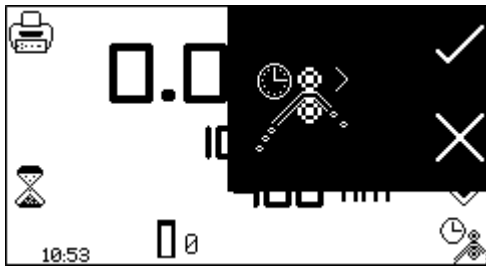

Confirmation will be needed to start the sipper pump. Press the key adjacent to the cross icon to cancel and return to the operating menu. Press the key adjacent to the tick icon to confirm and start the sipper pump. The pump will run for the previously recorded air gap take up time.

If an air gap of zero was previously selected this screen will not appear and the calibration sequence will continue to sample disposal.

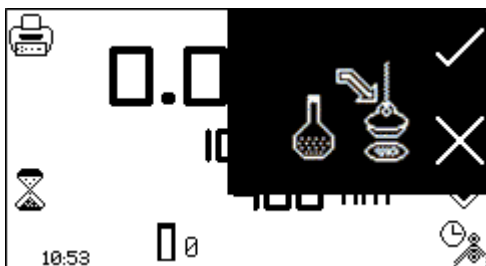

Once this stage of the calibration sequence is complete press the key below the sipper pump icon to dispose of the sample. Confirmation will be needed to start the sipper pump. Press the key adjacent to the cross icon to cancel and return to the operating menu. Press the key adjacent to the tick icon to confirm and

start the sipper pump. Depending on the disposal route previously selected the sample will either go to drain or back to the sample container.

8.3.4 Combined sipper Peltier pump

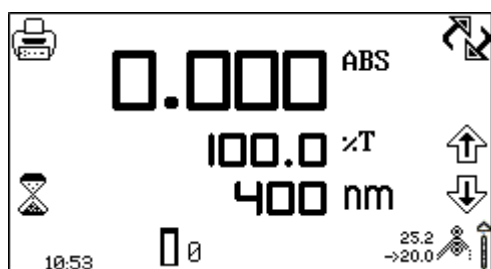

When the combined sipper Peltier is in use the sipper Peltier icon is displayed in the bottom right hand corner of the screen. The current temperature is displayed above the set point temperature adjacent to the sipper Peltier icon. Adjacent to the current temperature is an arrow to indicate if it is below or above the set

temperature. The pump direction is displayed by an arrow icon below the sipper Peltier icon. The combined sipper Peltier pump combines the functionality of the Peltier and sipper pump. To open the sipper Peltier settings hold the key below the sipper Peltier icon for 2 seconds.

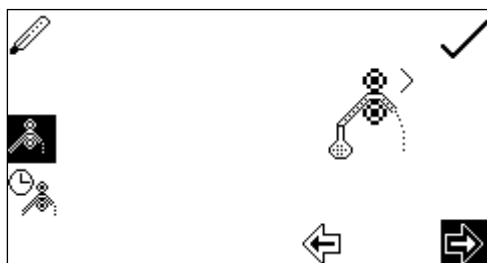

The settings menu is the same as the sipper pump settings except for the Peltier icon in the top left hand corner. Pressing the key adjacent to the Peltier icon will open the Peltier settings enabling the temperature to be set. Refer to section 8.3.2 for more details. The sipper pump can operate in a manual or timed mode. Refer to section 8.3 for more details.

8.4 SPARES

Part Code	Description of Spare Part
012 075	Tungsten halogen lamp
730 545	Xenon lamp module
735 801	10x10mm path length cuvette holder
060 084	Pack of 100 disposable plastic visible wavelength 10x10 cuvettes
060 230	Pack of 100 disposable plastic UV wavelength 10x10 cuvettes
037 702	Paper roll for printer
021 060	24V 65W power supply unit with various plug attachments

SECTION 9 – Maintenance and Service

9.1 ROUTINE MAINTENANCE

Ensure the external surfaces of the unit are clean and free from dust. The sample area should always be kept clean and any accidental spillage should be wiped away immediately. To give added protection when not in use, the unit should be disconnected from the mains supply and covered with the optional dust cover.

The only routine maintenance which may be required is the replacement of the light source. The replacement lamps are available from your local distributor (refer to section 8.4 for spare part codes). Only genuine replacement lamps should be used. Similar lamps may have different filament configurations or be wavelength restricted for domestic or commercial use and will give errors if used.

9.2 LAMP REPLACEMENT

9.2.1 Tungsten Halogen Lamp Replacement

This option is only valid for 7300 spectrophotometers.

Before replacing the lamp disconnect the unit from the mains supply and ensure the lamp is cool before handling. Access to the tungsten halogen lamp can be gained via the lamp access panel located on the rear of the instrument (refer to section 2.5).

1. Remove the screws holding the lamp access panel in place.
2. Withdraw the lamp access panel and unscrew the lamp bracket fixing screw.
3. Grasp and rotate the lamp bracket to gain access to the lamp.
4. Remove the old lamp from the holder. The lamp is a plug-in fit and should be removed by gently easing it from the holder.
5. Carefully remove the replacement lamp from the packaging. Ensure that the glass portion of the lamp is not touched as finger marks will damage the lamp resulting in a reduced performance. If accidental damage occurs the surface of the lamp may be cleaned using propan-2-ol.
6. Insert the lamp into the holder, ensuring it is fully pushed home.
7. Rotate the lamp bracket and put back into operational position. Replace the lamp bracket fixing screw and tighten.
8. Replace the lamp access panel and fix in place with the two screws.
9. Reconnect the power supply, turn on the unit and ensure that the lamp is illuminated after a few seconds.

For further instructions refer to the service manual.

9.2.2 Xenon Lamp Module Replacement

This option is only valid for the 7305 spectrophotometers and must be done by an accredited service engineer. Refer to section 9.3 for more details.

9.3 SERVICE

Our dedicated service staff are on hand to help in the unlikely event that your Jenway equipment develops a fault. Please contact them by one of the following means with a clear description of the problem:

E-mail: service@bibby-scientific.com

Tel: +44 (0) 1785 810475

Fax: +44 (0) 1785 810471

On occasion it may be necessary for your equipment to be sent back to our Service Department for repair. In this case please contact the Service Department for a reference number which you should include with your faulty equipment. Please also ensure you include a clear description of the fault and a completed copy of our Decontamination Certificate. This is available as a downloadable pdf file at www.jenway.com, or contact us and we will send you a copy. Please clearly mark the package for the attention of the Service Department and post to the following address:











Bibby Scientific Ltd
Beacon Road
Stone
Staffordshire
ST15 0SA
United Kingdom

All replacement parts are guaranteed for 1 year and where ever possible, returned equipment is turned around in 10 working days.

SECTION 10 – Troubleshooting

10.1 ERROR CODES

If an error code is displayed it will be accompanied by a spanner icon and a symbol to indicate if the error is a warning (caution icon) or fatal (stop icon). If the error is fatal contact your local distributor or Jenway service department (refer to section 9.3). If the error is a warning it may be possible to retry the test. In this case a back icon will also be displayed. The table below shows the error codes:

Error Code	Symbol	Issue
Err 1	  Fatal	System Parameters Failure This error indicates that the essential system parameters are corrupt. The most likely causes of this error are: 1. Fram chip failure. Solution: Restart the unit, if the problem persists contact a service technician.
Err 2	  Warning 	Operating Parameters Failure This error is a warning that the method and other user parameters have been reset. The most likely causes of this error are: 1. The methods were reset by pressing the top left button during the power on tests performed when the instrument is turned on. 2. The parameters have been corrupted so the instrument has reset itself. Solution: Press the key adjacent to the tick icon to action.
Err 3	  Warning  Redo	Dark Calibration Error This error indicates that the dark level is too high during calibration. In normal operation the lamp is switched off during an operator initiated calibration sequence to ensure that the detector output is below a threshold level. The calibration is aborted and Err 3 is displayed if the detector output is above the threshold level. The most likely causes of this error are: 1. The sample chamber lid has been left open during the calibration sequence. 2. The sample chamber lid was opened during the calibration sequence. 3. There is a fault on the detector PCB. Solution: Ensure the sample chamber is closed completely. Press the key adjacent to the back icon to retry the dark calibration.
Err 4	  Fatal	Microswitch Failure (service only) This error indicates that the microswitch was not found. The most likely causes of this error are: 1. The microswitch is broken. Solution: Contact a service technician.
Err 5		Light Saturation Not Found This error indicates that the peak light hasn't been found at zero.



Fatal

The most likely causes of this error are:

1. Lamp failure.
2. Deteriorating lamp signal.
3. Sample or cuvette in the sample holder.

Solution:

Ensure the sample holder is empty. Restart the unit, if the problem persists contact a service technician.

Err 8



Warning

Unable to find Vane on Turret

This error indicates that the vane position zero on the turret cannot be found.

The most likely causes for this error are:

1. The turret carousel has been removed and not replaced.

Solution:

Check if the turret is in the sample chamber and inserted properly. Press the key adjacent to the back icon to try rechecking.



Redo

Err 9



Fatal

Over Temperature

This error indicates that the thermal switch has cut out.

The most likely causes for this error are:

1. Failure of the fan
2. Thermal switch not connected.

Solution:

Restart the unit, if the problem persists contact a service technician.

10.2 TROUBLESHOOTING GUIDE

Issue	Solution
Unable to achieve zero absorbance or 100% transmittance when calibrating	Ensure that there is not a sample in the sample chamber. Ensure the instrument lid is closed before and during the calibration. Ensure the lamp is working – if the lamp has failed replace the lamp (7300) or lamp module (7305).
Unable to achieve a reading when measuring a sample	Ensure the correct cuvette is being used so that light isn't being absorbed by the cuvette. Ensure the sample isn't too dense that light is not transmitted through the sample. Ensure the lamp is working.
The measure sample icon disappears after changing the wavelength	A calibration must be performed at the new wavelength. When the calibration is complete the measure sample icon will be displayed.
Unable to print results using the internal printer	Ensure internal printer selected in autolog menu. Ensure there is paper in the unit. Ensure there is a result displayed on the screen.

10.3 TECHNICAL SUPPORT

Jenway have a dedicated Technical Support team made up of experienced scientists who are on hand to help with any applications advice and questions you may have about our products and how to use them. If you require any technical or application assistance please contact the team at:

E-mail: jenwayhelp@bibby-scientific.com

Phone: +44 (0)1785 810433

Fax: +44 (0)1785 810405

SECTION 11 – Declaration of Conformity

Declaration of Conformity

Visible Spectrophotometer, Model 7300

This product complies with the requirements of the EU Directives listed below:

2004/108/EC **EMC Directive.**
2006/95/EC **Low voltage Directive (LVD)**

Compliance with the requirements of these Directives is claimed by meeting the following standards:

EN 61326-1:2006 (Electrical Equipment for Measurement, Control and Laboratory use).
EN 61010-1: 2001
(Safety Requirements Electrical Equipment for Measurement, Control and Laboratory use)

CE mark affixed 2010

Signed:  (Mr C. Warren)

Date: APRIL 2010

Authority: Technical Director
Bibby Scientific Ltd

Bibby Scientific

Bibby Scientific Ltd - Stone - Staffs - ST15 0SA - UK
Tel: +44 (0) 1785 812121 - Fax +44 (0) 1785 813748

Declaration of Conformity

UV/Visible Spectrophotometer, Model 7305

This product complies with the requirements of the EU Directives listed below:

2004/108/EC **EMC Directive.**
2006/95/EC **Low voltage Directive (LVD)**

Compliance with the requirements of these Directives is claimed by meeting the following standards:

EN 61326-1:2006 (Electrical Equipment for Measurement, Control and Laboratory use).
EN 61010-1: 2001
(Safety Requirements Electrical Equipment for Measurement, Control and Laboratory use)

CE mark affixed 2010

Signed:  (Mr C. Warren)

Date: APRIL 2010

Authority: Technical Director
Bibby Scientific Ltd

 Bibby Scientific







Bibby Scientific Ltd - Stone - Staffs - ST15 0SA - UK
Tel: +44 (0) 1785 812121 - Fax +44 (0) 1785 813748

SECTION 12 – Glossary of Icons

Mode	ICON	Description
Common		Back key
Common		Tick icon - Done/yes
Common		Cross icon – Cancel/no
Common		Printer icon - Print/open printer settings
Common		No results to send to printer
Common		Computer icon - RS232 serial port for connection to an external printer or a computer
Common		No results to send to RS232
Common	English	English icon - Language selection
Common		Arrow icon - Results page down, move left, decrease
Common		Arrow icon - Results page up, move right, increase
Common		Arrow icon – Move down, decrease
Common		Arrow icon – Move up, increase
Common		Calibrate to zero icon
Common	400nm	Wavelength
Common		Lamp cold
Common		Lamp save
Common		Caution icon – accompanied by error code
Common		Check number
Common		Stop icon – accompanied by error code
Main Menu	<p>100.0 PPM 0.000 AAS</p> <p>xF </p>	Opens concentration measurement mode

Main Menu		Opens photometrics measurement mode
Main Menu		Instrument settings
Main Menu	12.00	Time/date icon
Time & Date		Clock icon - Set time
Time & Date		Calendar icon - Set date
Time & Date		Toggle icon – Switches date format
Autolog		Autolog icon - Opens auto log menu
Autolog		Printer icon - Auto log to printer
Autolog		Computer icon - Auto log to PC/external printer through RS232 serial port
Autolog		Sample icon - Number of sample measurement repetitions
Autolog		Timer icon - Time interval between each sample measurement repetition
Instrument Settings		Contrast
Instrument Settings		Lamp save
Photometrics		Measure sample
Photometrics		Toggle icon – switches between ABS/%T
Concentration		Settings menu
Concentration	----	Units icon – opens unit selection screen
Concentration		Resolution
Concentration		Measure to a factor
Concentration		Measure to a standard
Concentration	0.000 ABS	Calibrate to zero absorbance
Concentration	0.000	Calibrate to a standard
Concentration		Calibrate to zero absorbance or standard

Concentration		Factor menu
Concentration		Standard menu
Concentration	001	Resets standard or factor value to one
Concentration		Check standard
Accessories		No single cell - Method created on a unit with a single cell accessory fitted
Accessories		8 cell turret icon – the automatic 8 cell turret is in use
Accessories		Error finding cell position 0 on turret
Accessories		No turret - Method created on a unit with a turret accessory fitted
Accessories	°C	Degrees Celsius
Accessories	°F	Degrees Fahrenheit
Accessories		Peltier accessory in use – current temperature is below set point. The current temperature is displayed above set point temperature
Accessories		No Peltier - Method created on a unit with a Peltier accessory fitted
Accessories		Sipper pump in use – running in forward direction
Accessories		Sipper pump in use – running in reverse direction
Accessories		Timed sipper pump
Accessories		Timed sipper pump calibration sequence
Accessories	>	Start sipper pump – enables take up time to be set
Accessories	>>	Skip take up time – uses the previously set take up time
Accessories	■	Stop sipper pump
Accessories	001	001 – sets air gap to one

Accessories		Reduce sample uptake/reduce air gap
Accessories		Increase sample uptake/increase air gap
Accessories		No sipper - Method created on a unit with a sipper accessory fitted
Accessories		Sipper Peltier pump in use
Accessories		No sipper Peltier - Method created on a unit with a sipper Peltier accessory fitted
Accessories		PC comms - shown when the instrument is connected to a PC and communicating via the PC software
Error		Spanner – refer to section 10



Bibby Scientific Ltd

Beacon Road Stone
Staffordshire ST15 0SA
United Kingdom
Tel: +44 (0)1785 812121
Fax: +44 (0)1785 813748
e-mail: info@bibby-scientific.com
www.bibby-scientific.com

Bibby Scientific France SAS

ZI du Rocher Vert - BP 79
77793 Nemours Cedex
France
Tel: +33 1 64 45 13 13
Fax: +33 1 64 45 13 00
e-mail: bsf@bibby-scientific.fr
www.bibby-scientific.com

Bibby Scientific Ltd. – Singapore

Prudential Tower, Level 26,
30 Cecil Street 049712
Singapore
Tel: +65 6631 2976
Fax: +44 (0) 1785 810405
e-mail: bibby@bibby-scientificasia.com
www.bibby-scientific.com

Bibby Scientific Middle East Ltd

BPO Box 27842
Engomi 2433
Nicosia Cyprus
Tel: +357 22 660 423
Fax: +357 22 660 424
e-mail: sales@bibby-scientificme.com
www.bibby-scientific.com

Bibby Scientific US Ltd

3 Terri Lane Suite 10
Burlington NJ 08016
USA
Tel: 800-225-9243
Fax: 609-589-2571
www.bibby-scientific.com