

# Cole-Parmer®

## FB-200 Series

### Paraffin Section Flotation Bath

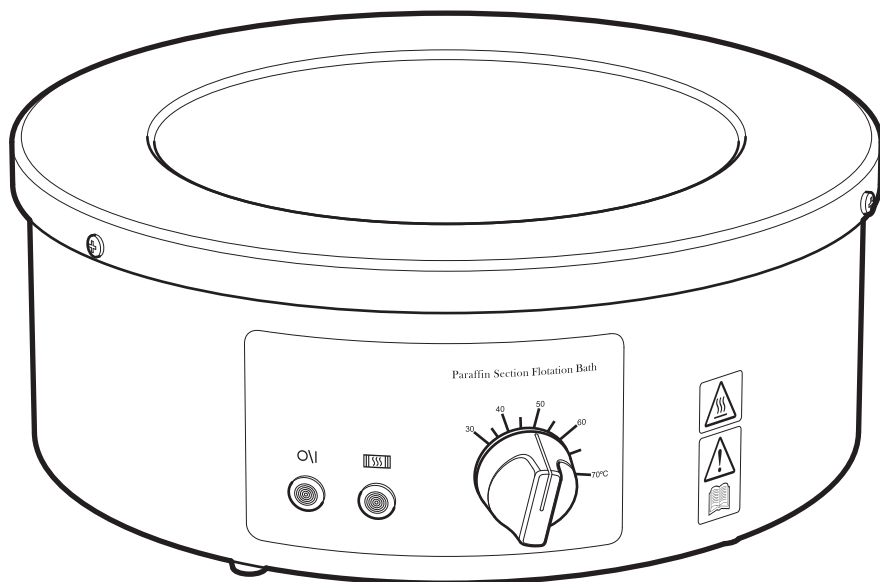

Instruction Manual  
M6847 Version 1.3

**Cole-Parmer®**  
essentials

Please take your time to read this Instruction manual in order to understand the safe and correct use of your new Cole-Parmer product.

It is recommended the responsible Body for the use of this equipment reads this instruction manual and ensures the user(s) are suitably trained in its operation.

| <b>Contents</b>                                     | <b>Page</b> |
|---|-------------|
| Section 1 Introduction                              | 3           |
| Section 2 Symbols and using this Instruction Manual | 4           |
| Section 3 Safety Information                        | 5           |
| Section 4 Unpacking and Contents                    | 7           |
| Section 5 Installation                              | 8           |
| Section 6 Environmental Protection                  | 9           |
| Section 7 Equipment Operation                       | 9           |
| Section 8 Technical Specifications                  | 11          |
| Section 9 Maintenance                               | 12          |
| Section 10 Spares and Accessories                   | 14          |
| Section 11 Customer and Technical Support           | 14          |
| Section 12 Declaration of Conformity                | 15          |

*© The copyright of this instruction manual is the property of Antylia Scientific Limited. This instruction manual is supplied by Antylia Scientific Limited on the express understanding that it is to be used solely for the purpose for which it is supplied. It may not be copied, used or disclosed to others in whole or part for any purpose except as authorised in writing by Antylia Scientific Limited. Antylia Scientific Limited reserves the right to alter, change or modify this document without prior notification.*

*In the interest of continued development Antylia Scientific Limited reserve the right to alter or modify the design and / or assembly process of their products without prior notification.*

**This product is manufactured in Great Britain by Cole-Parmer, part of the Antylia Scientific Group of companies.**

**Antylia Scientific Ltd.**

Beacon Road,  
Stone,  
Staffordshire,  
ST15 0SA,  
United Kingdom  
Tel: +44 (0)1785 812121

## 1. INTRODUCTION

The FB-200 Paraffin section mounting bath is designed for use as a heated, distilled water floating out bath for the manipulation and location of paraffin wax sections onto glass slides.

The black PTFE coated interior gives a high contrast background for locating specimens.

The FB-200 Paraffin bath uses an electronic temperature controller with thermocouple sensor feedback designed to supply power to a silicon rubber mat heater in order to maintain accurate water temperatures. A self resetting over temperature cut out device is fitted as an integral part of the heater mat in order to protect against any over temperature conditions.

This product is supplied with an IEC moulded cord and lead set for ease of operation and the IEC socket houses protection fuses for both the live and neutral power supply lines. A White neon indicates the presence of power while the Amber neon indicates when the heater is in an 'on' state.

## 2. SYMBOLS AND USING THIS INSTRUCTION MANUAL

- 2.1. Throughout this Instruction manual the following symbols are shown to identify conditions which pose a hazard to the user, or to identify actions that should be observed. These symbols are also shown on the product, or its packaging. When a symbol is shown next to a paragraph or statement it is recommended the user takes particular note of that instruction in order to prevent damage to the equipment or to prevent injury to one's self or other people.

**The Responsible Body and the Operator should read and be familiar with this instruction manual in order to preserve the protection afforded by the equipment.**

**To prevent injury or equipment damage it is the manufacturer's recommendation that all persons using this equipment are suitably trained before use.**

### 2.2. Symbols Defined.



Caution, risk of danger. See note or adjacent symbol.



Protective conductor terminal to be earthed.  
(Do not loosen or disconnect).



Caution / Risk of electric shock.



Recyclable Packaging Material.



Do not dispose of product in normal domestic waste.



Caution. Hot surface.



Refer to Instruction manual.



ON/OFF symbol. Lamp is illuminated when equipment is 'ON'.



Heater symbol. Lamp is illuminated when heater is 'ON'.



Bio Chemical Hazard. Caution required. Will require decontamination.

### 3. SAFETY INFORMATION

This product has been designed for safe operation when used as detailed in accordance with the manufacturer's instructions.

**NOTE:** Failure to use this equipment in accordance with this instruction manual may compromise your basic safety protection afforded by the equipment and may invalidate the warranty / guarantee. The warranty / guarantee does not cover damaged caused by faulty installation or misuse of the equipment.

#### 3.1. Prevention of Fire and Electric shock.

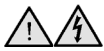

To prevent a risk of fire or electric shock, **do not** open your product case without authorisation. Only qualified Service personnel should attempt to repair this Controller.



Only replace fuses with the type as listed in Technical Specification section (See fuse type and rating).

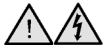

Ensure the Mains Power Supply conforms to rating found on the data plate located on the back of this product.

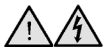

**Never** operate this equipment with out connection to earth / ground. Ensure the mains supply voltage is correctly earthed / grounded in accordance with current area legislation.



**Do not** install or remove any heating apparatus from the controller whilst power is applied.

#### 3.2. General Safe Operating Practice.



Always follow good laboratory practice when using this equipment. Give due recognition to your company's safety and legislative health & safety procedures and all associated legislation applicable to your areas of operation.



Ensure equipment is used on a clean, dry, non-combustible, solid work surface with at least 300mm suitable clearance all around from other equipment.



**Do not** position the product so that it is difficult to disconnect from the mains supply.



**Do not** lean or stretch over equipment.



**Do not** immerse unit in water or fluids.



**Do not** spill chemicals over this product. If spillage does occur, disconnect unit from mains supply and follow instructions as detailed in Maintenance, (Section 9).



**Do not** cover this equipment whilst in use or obstruct cooling vents.



**Do not** leave equipment switched on when empty.



It is **not** recommended to leave any heating apparatus unattended during operation.



Only use Original Equipment manufacturer's spares and accessories. Ref Section 10.



The equipment is not spark, flame or explosion proof and has not been designed for use in hazardous areas in terms of BSEN 60079-14:1997. Keep flammable, low flash point substances away from the apparatus.



**Do not** operate or handle any part of this product with wet hands.

**NOTE:** *if this product is not used in accordance with the Manufacturer's Instructions then the basic safety protection afforded by the equipment may not be preserved and the guarantee invalidated.*

#### 4. UNPACKING AND CONTENTS

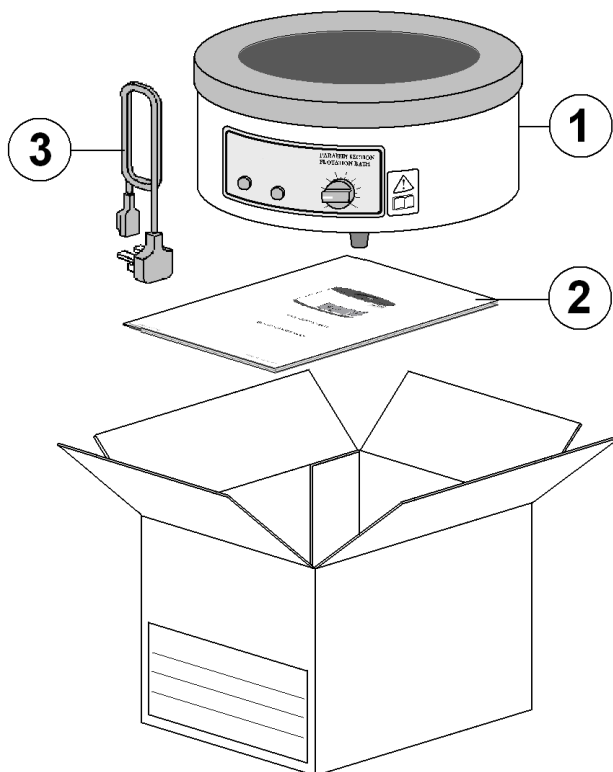

#### Contents.

| Item | Description  | Qty |
|------|--|-----|
| 1    | Paraffin Section Mounting Bath   | 1   |
| 2    | Instruction book ( <i>this document</i> ).   | 1   |
| 3    | Mains lead and moulded IEC plug set.<br><i>(Illustration may be different to lead set supplied depending on country of use).</i> | A/R |



|  |                      |                     |
|--|----------------------|---------------------|
| <b>For future reference<br/>please record your<br/>products Serial and<br/>Model Number.</b> | <b>Serial Number</b> | <b>Model Number</b> |
|  |                      |                     |

## 5. INSTALLATION

### 5.1. Electrical safety and Installation

5.1.1 This equipment is designed for safe operation under the following conditions:-

- Indoor use.
- Altitude up to 2000 meters.
- Temperatures between 5°C and 40°C.
- Maximum relative humidity 80% for temperatures up to 31°C decreasing linearly to 50% relative humidity at 40°C.
- Mains supply voltage fluctuations up to  $\pm 10\%$  of the nominal voltage.
- Transient overvoltages typically present on the mains supply. (Overvoltage category II).
- Applicable rated pollution degree 2.

- 5.2.  This equipment must be earthed / grounded to a fixed earth / grounded mains socket outlet. The mains supply is to be earthed / grounded in accordance with current legislation.
- 5.3. Ensure only the correct rated mains input fuses are fitted. (Where applicable ensure the correct Mains cord and moulded IEC plug and lead set fuse if fitted). See Technical Specification Section 8 of this Instruction manual.
- 5.4. Check the voltage on the product data label on this product unit. Ensure the rating conforms to your local supply.
- 5.5. It is recommended this product be connected to a mains supply source which incorporates an RCD or GFCI device.
- 5.6.  Do not install this product or accessories on a surface which may become wet.
- 5.7. The unit is supplied with a Mains cord wired as follows: 
- Green /Yellow or Green = Earth / Ground
- Blue or White = Neutral
- Brown or Black = Live / line hot.



## 6. ENVIRONMENTAL PROTECTION

6.1. Maximum consideration to environmental issues within the design and manufacturing process without compromising end product performance and value.

6.2.  Packaging materials have been selected such that they may be sorted for recycling.

6.3.  At the end of your product and accessories life, it must **not be** discarded as domestic waste. Ref: EU Directive 2002/96/EC on Waste Electrical and Electronic Equipment Directive (WEEE). Please contact your distributor / supplier for further information. For end users outside of the EU consult applicable regulations.

6.4. This product should only be dismantled for recycling by an authorised recycling company.



***This product and accessories must be accompanied by a completed Decontamination Certificate prior to any Disposal. Copies of the Certificate are available from Distributor/Manufacturer.***

## 7. EQUIPMENT OPERATION

7.1. The Paraffin Bath has been designed for easy operation. The illustration below shows a detailed layout of the product.

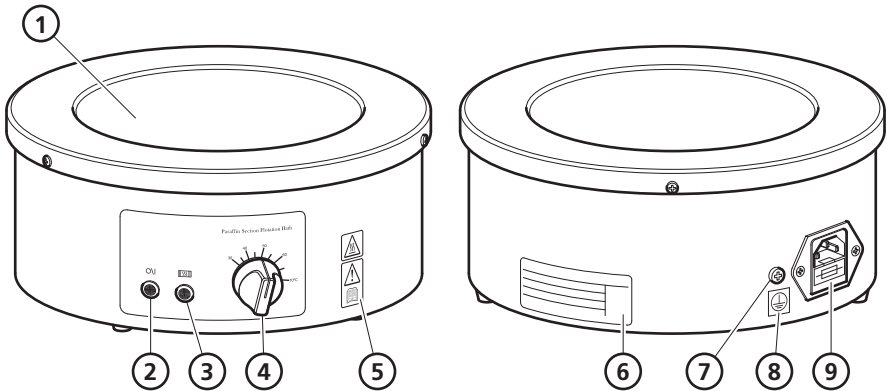

- 1 Bath tank
- 2 Mains power on neon (White)
- 3 Heater on neon (Amber)
- 4 Temperature control regulation dial
- 5 Read instruction manual label
- 6 Data plate label
- 7 Earth bonding test point
- 8 Earth bonding point attention label
- 9 Mains IEC plug socket and protection fuses

- 7.2. With the unit disconnected from the mains electricity supply, fill the bath tank with 2 Litres of distilled water.

**Note:** For best operation of this equipment, fill the unit with sterilized distilled water. The acceptable resistivity range is 50K to 1 Megohms (conductivity 1 to 20 micro Siemens). The acceptable pH range is 7 to 9.

**Caution:** Using chlorinated tap water or additives that contain chlorine will void the manufacture warranty. Similarly, high purity (deionized) water that does not fall within a resistivity range of 50K to 1 Megohms and pH range of 7 to 9 will void the manufacture warranty. If you have any questions, please contact Customer support (see page 15 of this instruction manual).

- 7.3. Plug the unit into the mains electrical supply. Observe the illumination of the White neon indicating the presence of power.

- 7.4. The control knob has a temperature scale from 30 to 70 °C.

Set the control knob to the required temperature

**Note:** On initial start-up from cold, the amber neon will be on continuously and will subsequently switch on and off with reducing 'on' periods as the required temperature setting is approached.

For more accurate temperature setting, check bath water temperature using a hand held thermometer or other suitable temperature measuring device and adjust the regulating knob as required.

- 7.5. If an over temperature condition occurs, the bath heater mat will turn off. Disconnect from the mains electricity supply and check there is sufficient distilled water in the bath. When the unit has cooled down the thermal cut out will reset and operation may recommence. If a lack of distilled water isn't the reason for the over temperature fault condition, refer to section 11 Customer support.



**Take care not to get hot distilled water onto hands/skin.**

- 7.6. Regularly check the volume of distilled water present in the unit. Replenish as required.
- 7.7. An optional lid can be purchased which reduces evaporation of bath water – order part code AZ9241. Send your enquiry to [cpsales@antylia.com](mailto:cpsales@antylia.com).

## 8. TECHNICAL SPECIFICATION

|  |  |
|--|--|
| Mains supply voltage                     | 115V – AC 50/60 Hz (FB-200-115)<br>230V – AC 50/60 Hz (FB-200)   |
| Maximum power                            | 115V = 175 Watts<br>230V = 240 Watts   |
| Operational temperature and performance. | 70°C nominal from ambient (25°C, with 2.3 litres water) obtained within 70 minutes or 45°C within 40 minutes |
| Temperature stability                    | ±0.5°C at constant ambient temperature, improved to ±0.25°C when using the lid AZ9241                        |
| HH179(S)                                 | Mains cord and moulded IEC plug and lead set cable (UK) 13A BS1362   |
| HH180(S)                                 | Mains cord and moulded IEC plug and lead set cable (Europe)  |
| CRM6288                                  | Mains cord and moulded IEC plug and lead set cable (USA)   |
| Lead set plug fuse (UK – only)           | 13A (BSEN1362)   |
| Fuse Rating                              | 230V = F1.25A 20mm x 5mm Glass Quickblow<br>115V = F2.5A 20mm x 5mm Glass Quickblow                          |
| Heating element                          | Silicone Rubber Mat Heater   |
| Over temperature protection              | Over temperature protection with resettable thermal cut out  |
| Maximum bath capacity                    | 2.3 litres (0.6 US gallon), (0.5 UK gallon)  |
| Case construction                        | Aluminium bath with PTFE coated interior. Powder coated aluminium white exterior                             |
| Neon indicators                          | Power on – Clear<br>Heater on – Amber  |
| Controls: Bath heater                    | Electronic temperature controller with thermocouple sensor feedback  |

**The Ingress protection rating for this product is classified as IPX 1.**

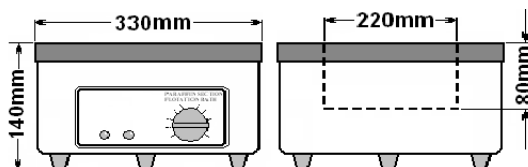

**Weight 2.7Kg**

## 9. MAINTENANCE

### 9.1. General Information.



Unplug the unit from the mains voltage supply and allow it to cool before undertaking any maintenance tasks.



**Maintenance should only be carried out under the direction of the Responsible Body, by a competent electrician. Failure to do so may result in damage to the product and in extreme cases be a danger to the end user.**

With proper care in operation this equipment has been designed to give many years of reliable service. Contamination or general misuse will reduce the effective life of this product and may cause a hazard.

#### **Maintenance for the unit should include:**

- Periodic electrical safety testing (an annual test is recommended as the minimum requirement).
- Regular inspection for damage with particular attention to the mains lead and plug set.
- Routine cleaning of the equipment should be undertaken using a clean cloth. Hot water may be used to remove any solidified wax. Allow the equipment to dry thoroughly before reconnecting the to the mains electricity supply.

#### **DO NOT USE SOLVENTS FOR CLEANING ANY PART OF THIS EQUIPMENT.**

### 9.2. Fuse Replacement.

The mains fuse holder is located at the side of this product. Refer to 'Fuse Rating' in the Technical Specification section for correct fuse type and rating. Turn your product off and remove it from the mains supply. Open fuse draw and remove fuses. Fit replacement fuses and close the draw.

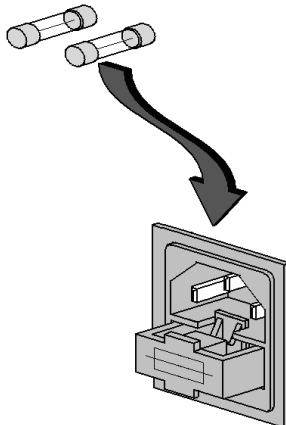

### 9.3. Spillage and Decontamination.

In the event of spillage switch off and unplug this product from the mains electrical supply. Empty the bath and wipe off all excess liquid from the bath and surrounding area using an absorbent soft cloth. Allow sufficient time for any liquid ingress to evaporate (unit can be placed in a warm oven up to 40°C to accommodate drying out).

**Prior to further use, the Responsible Body shall check the electrical safety of the unit. Only if all safety requirements are met can the unit be used again.**

If in doubt please consult Customer Support. Refer to section 11.



**If the equipment has been exposed to contamination, the Responsible Body is responsible for carrying out appropriate decontamination. If hazardous material has been spilt on or inside the equipment, decontamination should only be undertaken under the control of the Responsible Body with due recognition of possible hazards. Before using any cleaning or decontamination method, the Responsible Body should check with the manufacturer the proposed method will not damage the equipment.**

**Prior to further use, the Responsible Body shall check the electrical safety of the unit. Only if all safety requirements are met can the unit be used again. The above procedure is intended as a guide. Should spillage occur with a toxic or hazardous fluid then special precautions may be necessary.**

#### **Decontamination Certificate.**

**Note:** In the event of this equipment or any part of the unit becoming damaged, or requiring service, the item(s) should be returned to the manufacturer for repair accompanied by a completed decontamination certificate. **Copies of the Certificate are available from Distributor/Manufacturer.**

**At the end of life, this product must be accompanied by a completed Decontamination Certificate.**

## 10. SPARES AND ACCESSORIES

| <b>Order Number</b> | <b>Description</b>   |
|---------------------|--|
| AZ9241              | Paraffin bath lid  |
| HH179(S)            | Mains cord and moulded IEC plug and lead set cable (UK) 10A BS1362 |
| HH180(S)            | Mains cord and moulded IEC plug and lead set cable (Europe)        |
| CRM6288             | Mains cord and moulded IEC plug and lead set cable (USA)           |

Please contact your local sales specialist or email [cpspares@antylia.com](mailto:cpspares@antylia.com) to enquire about available spares.

Please visit [www.Cole-Parmer.com](http://www.Cole-Parmer.com) for a full list of available accessories.

## 11. CUSTOMER AND TECHNICAL SUPPORT

For help and support in using this product, please contact Customer Services at the following address:

Antylia Scientific Ltd.  
Beacon Road,  
Stone,  
Staffordshire,  
ST15 0SA,  
United Kingdom  
Tel: +44 (0)1785 812121

Service: [cpsservice@antylia.com](mailto:cpsservice@antylia.com)  
General enquiries: [cpinfo@antylia.com](mailto:cpinfo@antylia.com)  
Order enquiries: [cpsales@antylia.com](mailto:cpsales@antylia.com)  
Technical support: [cptechsupport@antylia.com](mailto:cptechsupport@antylia.com)

[www.coleparmer.com](http://www.coleparmer.com)

 This product meets the applicable CE Directives and UKCA Legislation for radio frequency interference and may be expected not to interfere with, or be affected by, other equipment with similar qualifications. We cannot be sure that other equipment used in its vicinity will meet these standards and so we cannot guarantee

that interference will not occur in practise. Where there is a possibility that injury, damage or loss might occur if equipment malfunctions due to radio frequency interference, or for general advise before use, contact the manufacturer.

Declaration of Conformity is available to view online at [www.coleparmer.com](http://www.coleparmer.com)

**EU Representative address**

Antylia Scientific GmbH  
Futtererstraße 16  
97877 Wertheim  
Deutschland  
Tel: +49 9377 9203-0  
Email: [sales@coleparmer.de](mailto:sales@coleparmer.de)

**UK Representative address**

Antylia Scientific  
9 Orion Court  
Ambuscade Road  
Colmworth Business Park  
St. Neots  
PE19 8YX  
United Kingdom  
Tel: +44 (0) 1480 277339  
Email: [enquiries@antylia.com](mailto:enquiries@antylia.com)

# Ordering Information

| Order No. | Series | Model      | Legacy SKU |
|-----------|--------|------------|------------|
| 48572-55  | FB-200 | FB-200     | MH8517     |
| 48572-50  | FB-200 | FB-200-115 | MH8517X1   |

## Warranty Registration



### UK

T: +44 (0) 1480 272279  
E: uk.sales@antylia.com  
W: coleparmer.co.uk

### Germany

T: +49 (0) 9377 92030  
E: de.sales@antylia.com  
W: coleparmer.de

### France

T: +33 (0) 1486 37800  
E: fr.sales@antylia.com  
W: coleparmer.fr

### Italy

T: +39 (0) 284349215  
E: it.sales@antylia.com  
W: coleparmer.it

### India

T: +9122 61394444  
E: info@coleparmer.in  
W: coleparmer.in

### China

T: +1 847 549 7600  
E: sales@antylia.com  
W: coleparmer.com

### USA

T: +1 847 549 7600  
E: sales@antylia.com  
W: coleparmer.com

### Canada

T: +514 355 6100  
E: info@antylia.ca  
W: coleparmer.ca

### Other

T: +1 847 549 7600

**Cole-Parmer®**  
essentials

**Antylia Scientific Ltd.**  
Beacon Road,  
Stone,  
Staffordshire,  
ST15 0SA,  
United Kingdom

